



# Coplanar

VENTANA DE MADERA 84,5mm





# Coplanar 84,5mm

Ventana madera:  
> 84,5mm  
(derivada de 68mm)

Marco: esp.:  
> 84,5mm

Hoja: esp.:  
> 84,5mm

Vidrio:  
> ?÷?mm

L 161509003

KBZ: H84.5



Ventana madera: 84.5mm  
(derivada de 68mm)  
Marco: esp.: 84.5mm  
Hoja: esp.: 84.5mm  
Vidrio: ?÷?mm

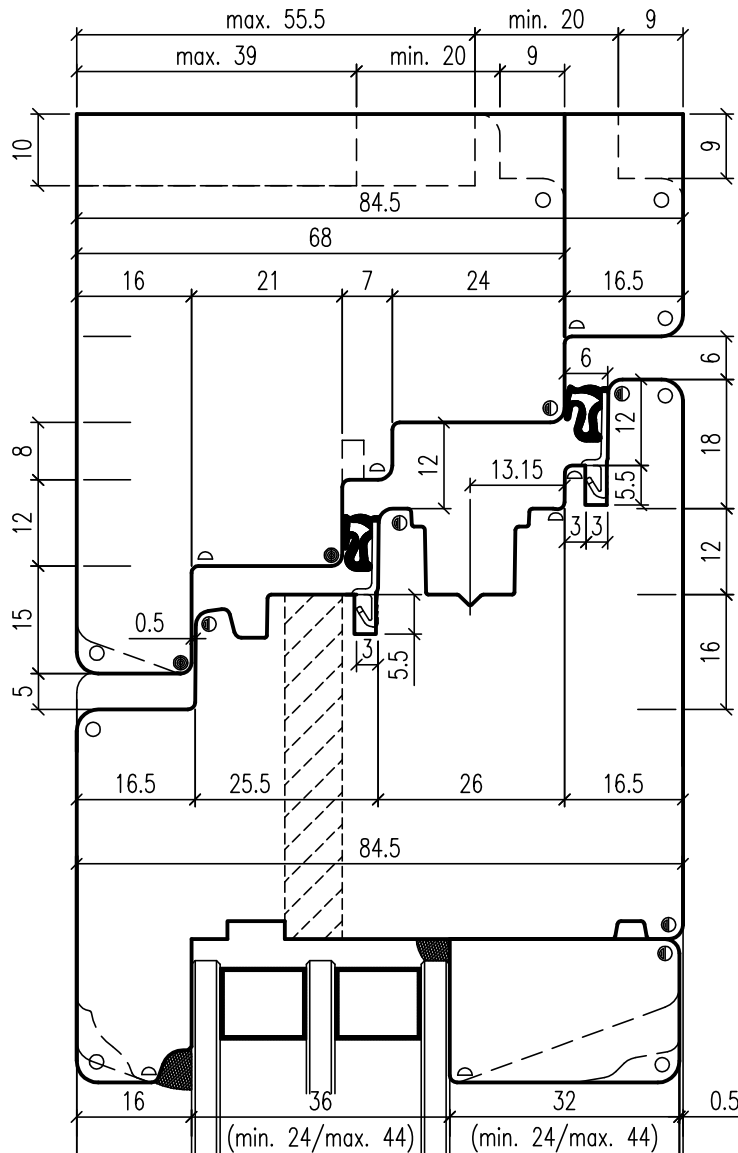
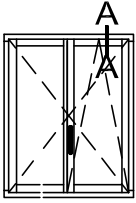

- ⊖ R 1.0
- R 1.5
- R 2.0
- R 3.0

Coplanar 84,5mm

L 161509003 PZ01

KBZ: H84.5



Ventana madera: 84.5mm  
(derivada de 68mm)  
Marco: esp.: 84.5mm  
Hoja: esp.: 84.5mm  
Vidrio: ?÷?mm

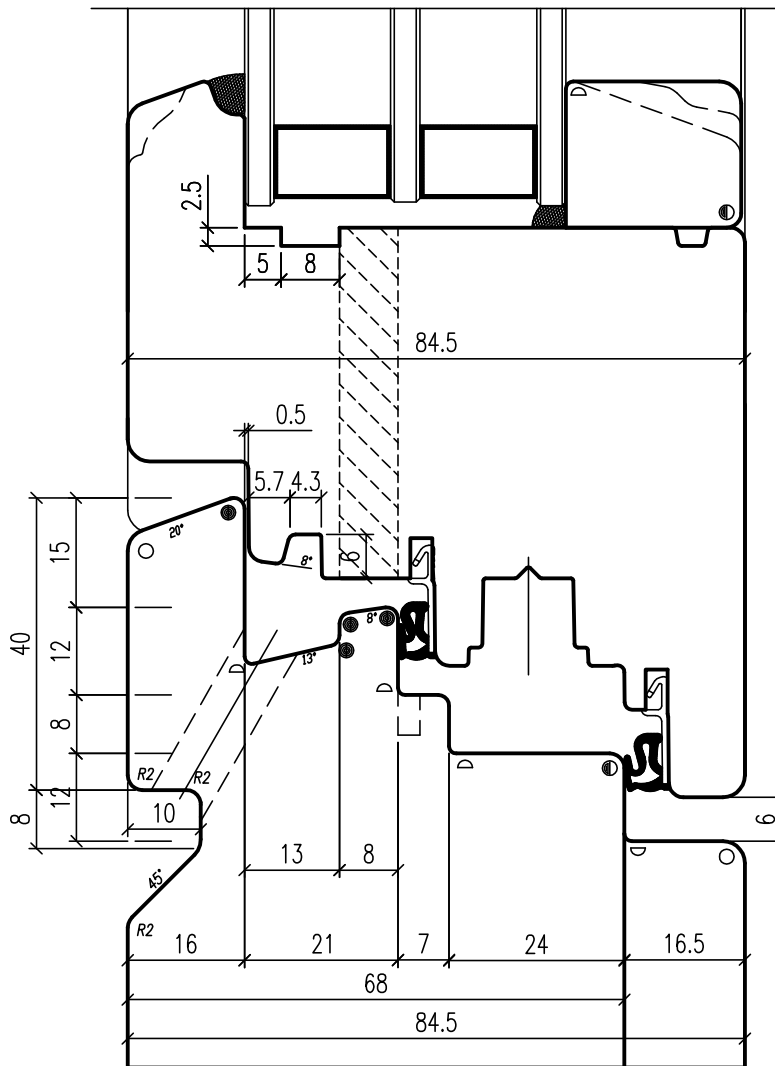
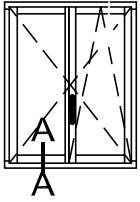

- ◐ R 1.0
- R 1.5
- R 2.0
- R 3.0

**Coplanar 84,5mm**

**L 161509003 PZ02**

KBZ: H84.5



Ventana madera: 84.5mm  
(derivada de 68mm)  
Marco: esp.: 84.5mm  
Hoja: esp.: 84.5mm  
Vidrio: ?-?mm

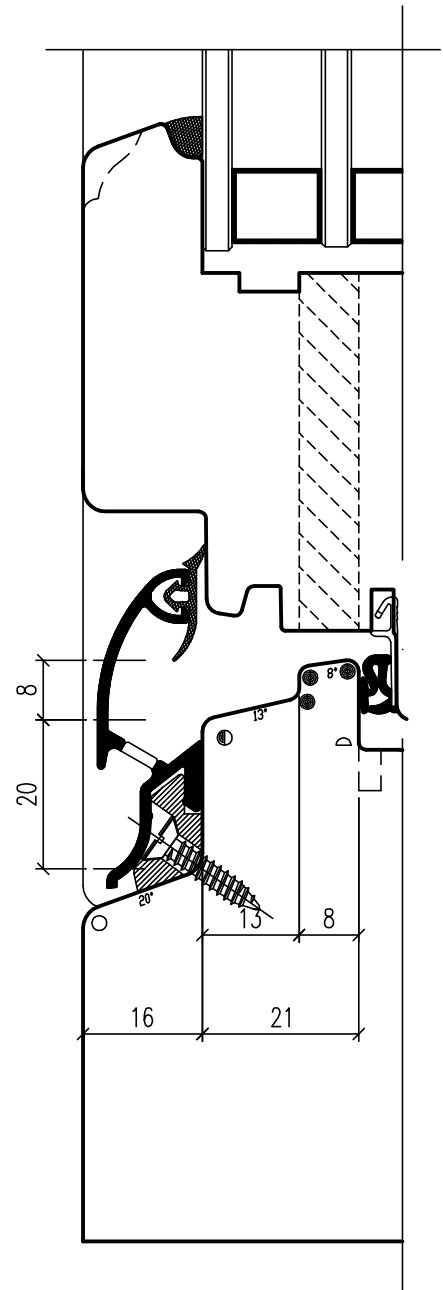
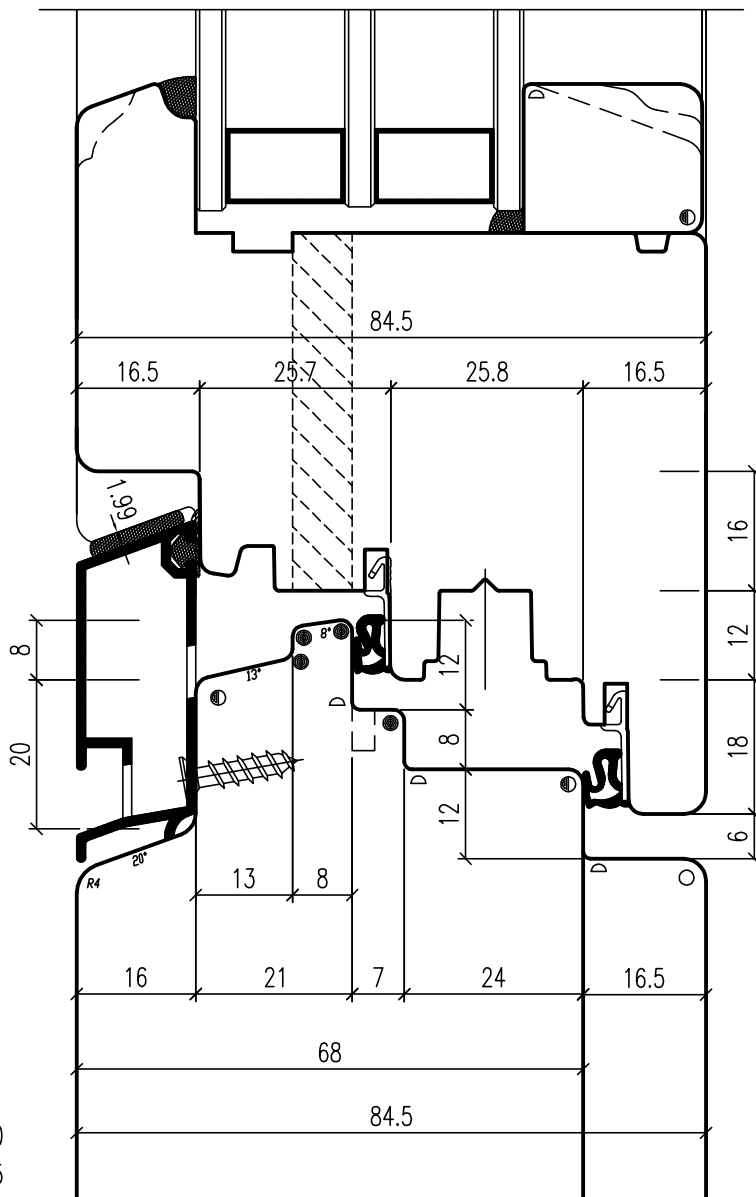
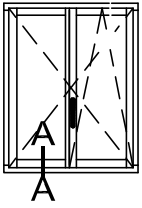

- ⊖ R 1.0
- R 1.5
- R 2.0
- R 3.0

**Coplanar 84,5mm**

**L 161509003 PZ03**

KBZ: H84.5



Ventana madera: 84.5mm  
(derivada de 68mm)  
Marco: esp.: 84.5mm  
Hoja: esp.: 84.5mm  
Vidrio: ?÷?mm

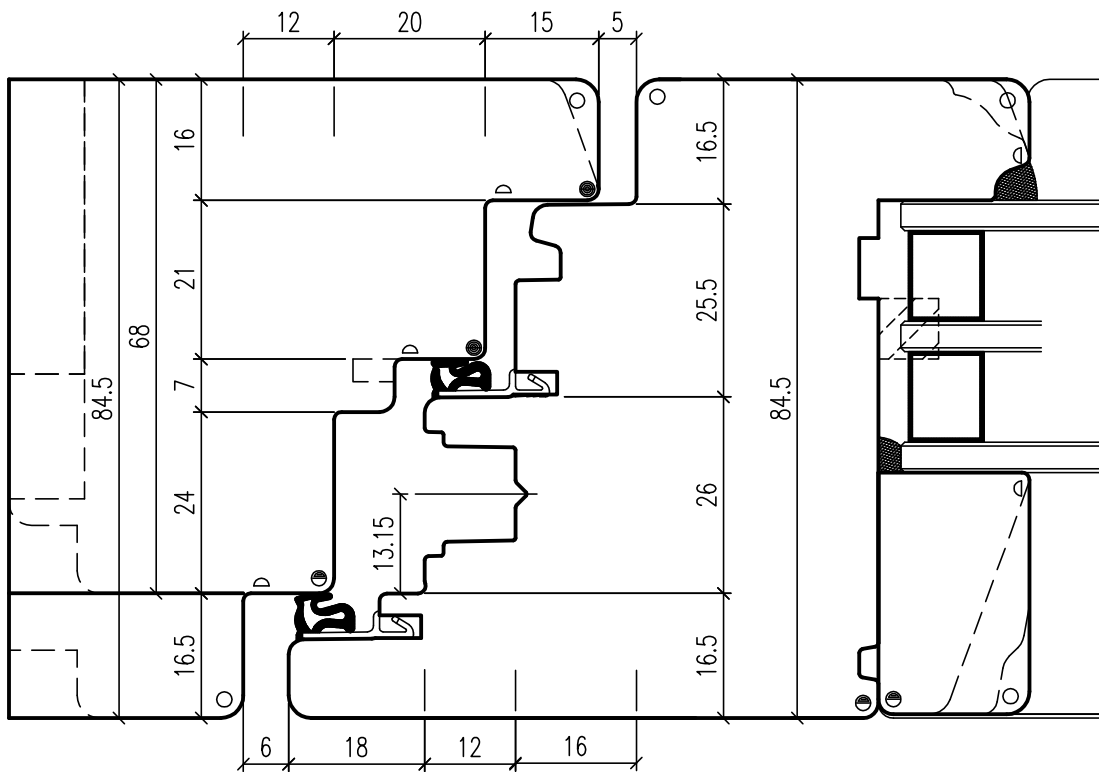
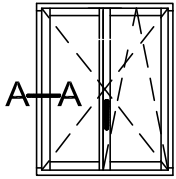

- ▷ R 1.0
- R 1.5
- R 2.0
- R 3.0

**Coplanar 84,5mm**

**L 161509003 PZ04**

Ventana madera: 84.5mm  
 (derivada de 68mm)  
 Marco: esp.: 84.5mm  
 Hoja: esp.: 84.5mm  
 Vidrio: ?÷?mm

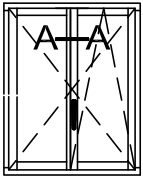

Variante 1  
 Goma en el cierre central On-Off

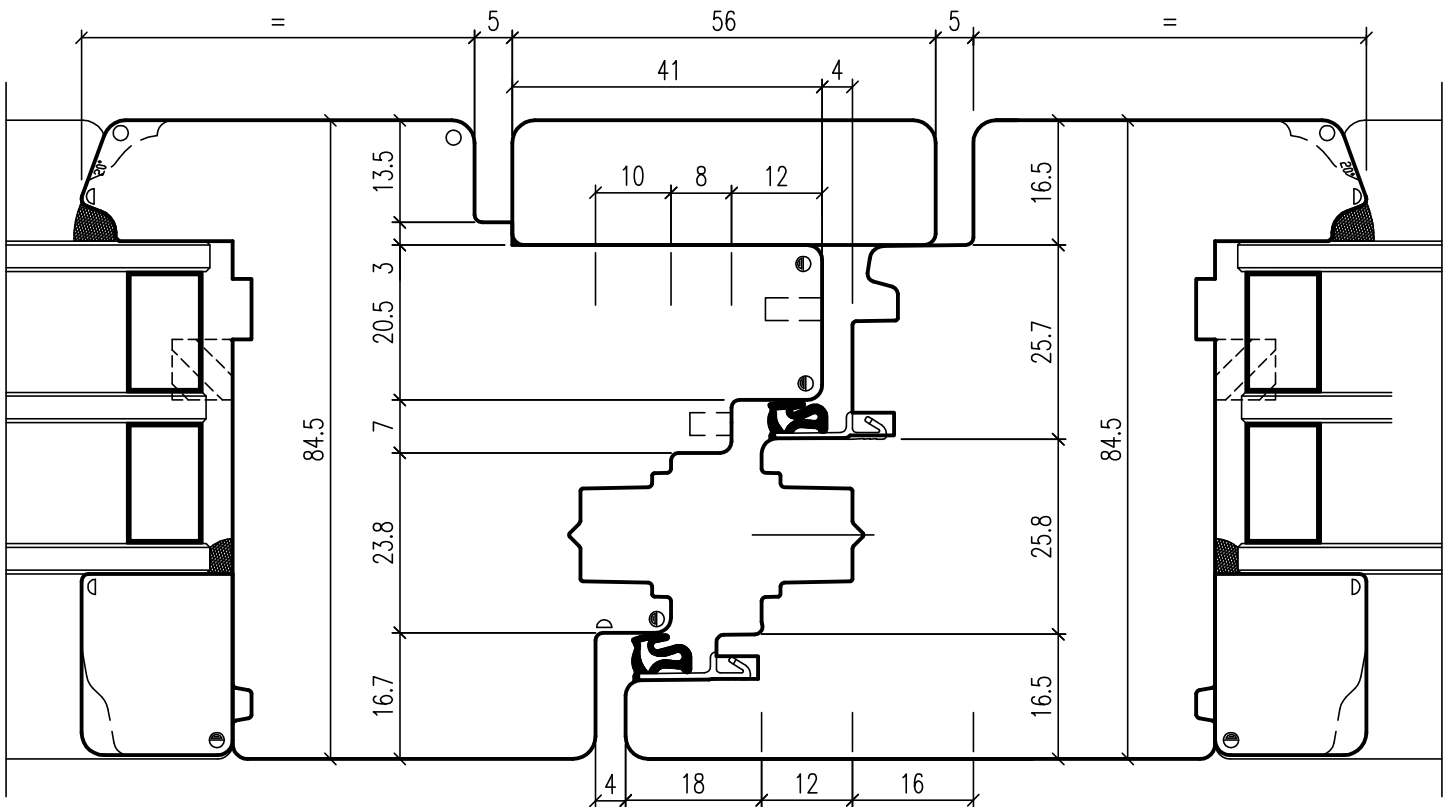
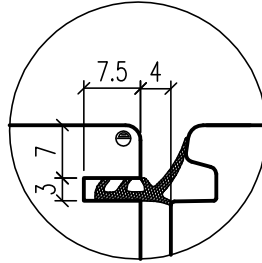

- ⊂ R 1.0
- R 1.5
- R 2.0
- R 3.0

**Coplanar 84,5mm**

**L 161509003 PZ06**

KBZ: H84.5



Ventana madera: 84.5mm  
 (derivada de 68mm)  
 Marco: esp.: 84.5mm  
 Hoja: esp.: 84.5mm  
 Vidrio: ?÷?mm

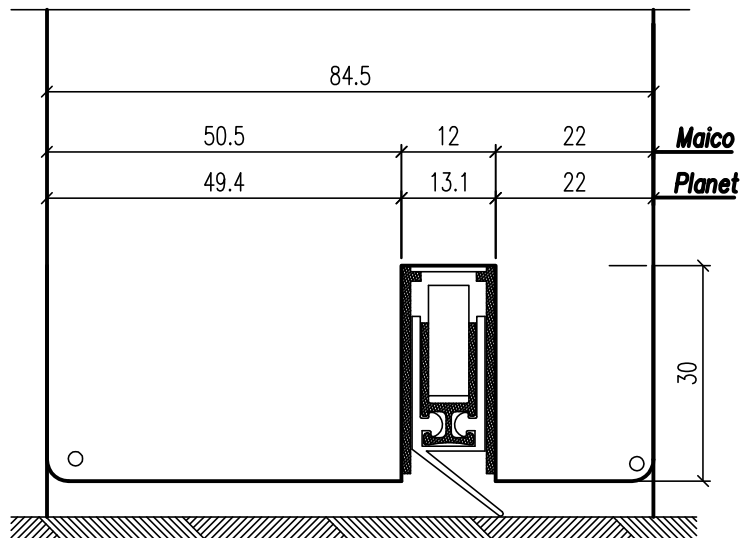
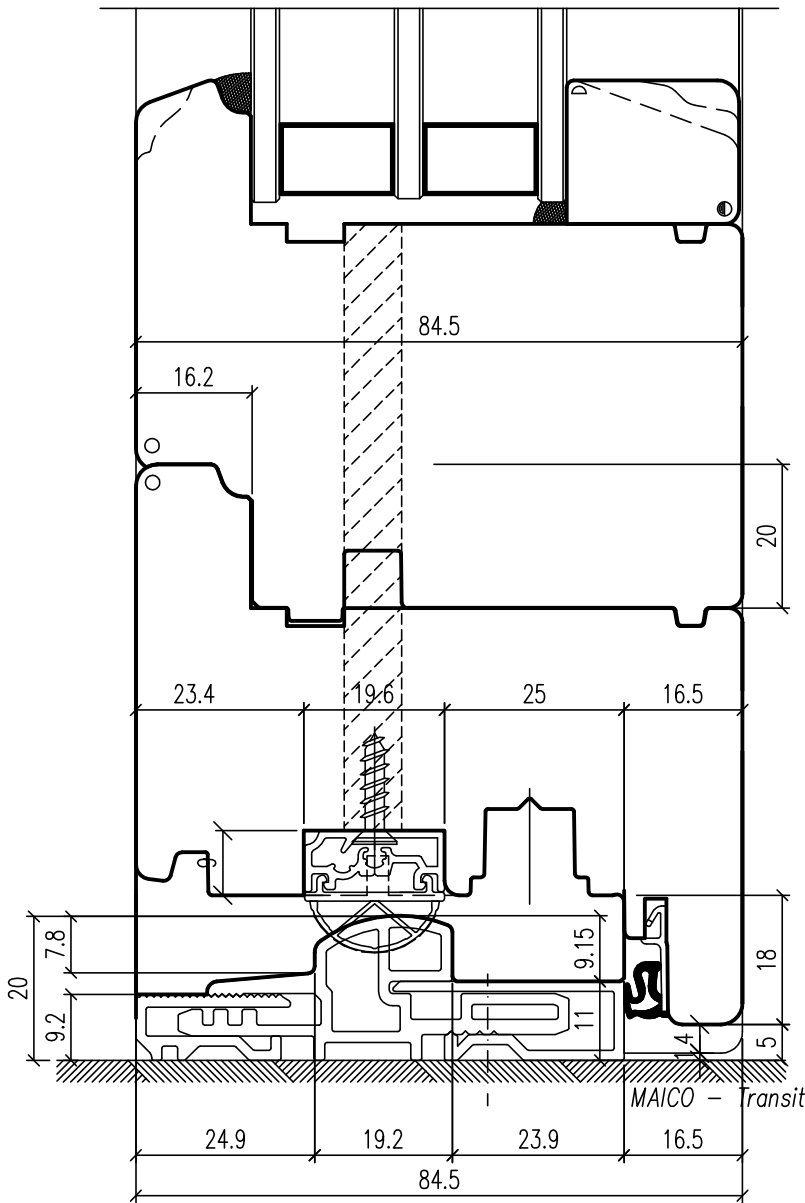
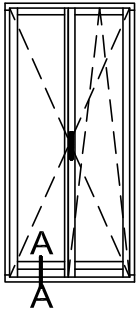

- R 1.0
- R 1.5
- R 2.0
- R 3.0

**Coplanar 84,5mm**  
**L 161509003 PZ07**



KBZ: H84.5



Ventana madera: 84.5mm  
(derivada de 68mm)  
Marco: esp.: 84.5mm  
Hoja: esp.: 84.5mm  
Vidrio: ?÷?mm

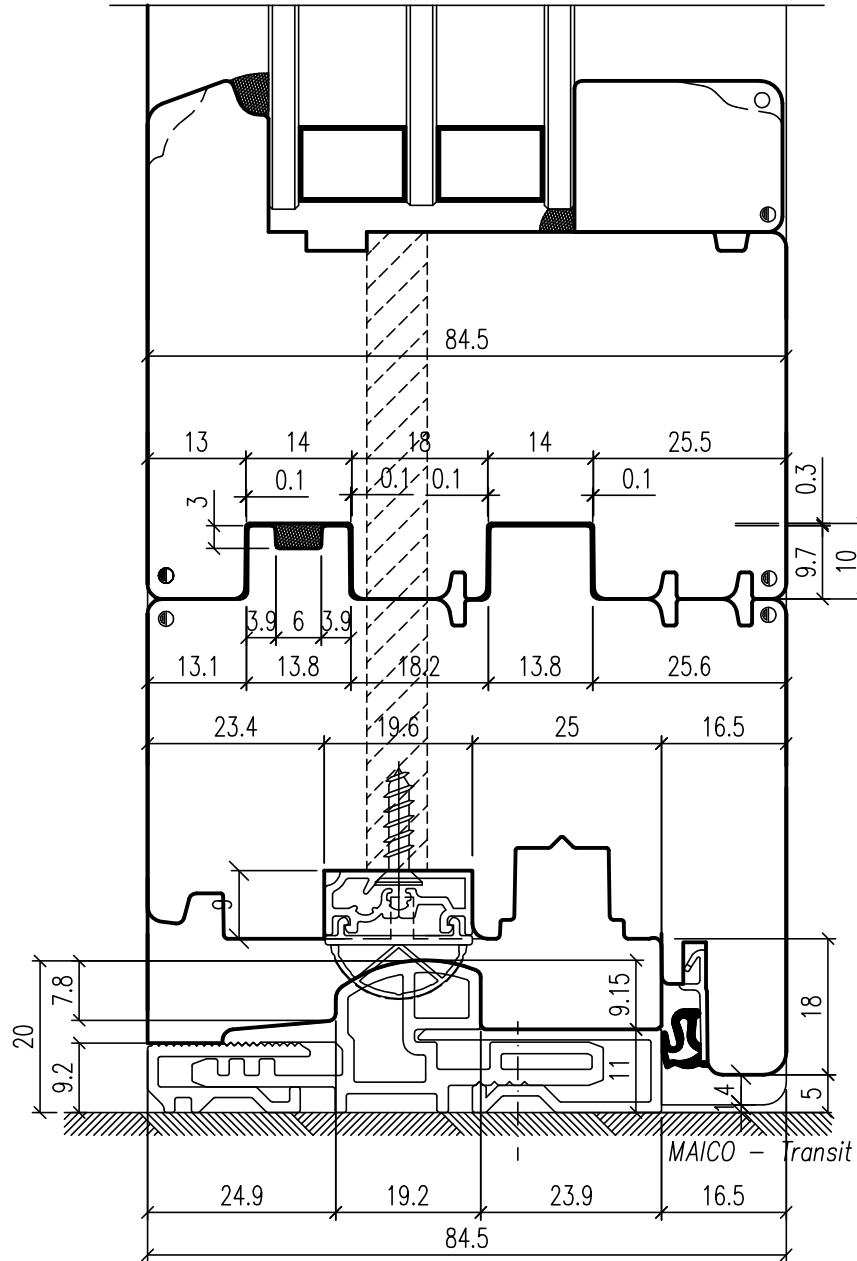
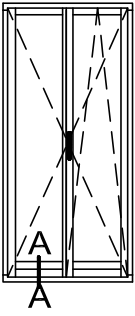

- ∅ R 1.0
- R 1.5
- R 2.0
- R 3.0

Coplanar 84,5mm

L 161509003 PZ08

KBZ: H84.5

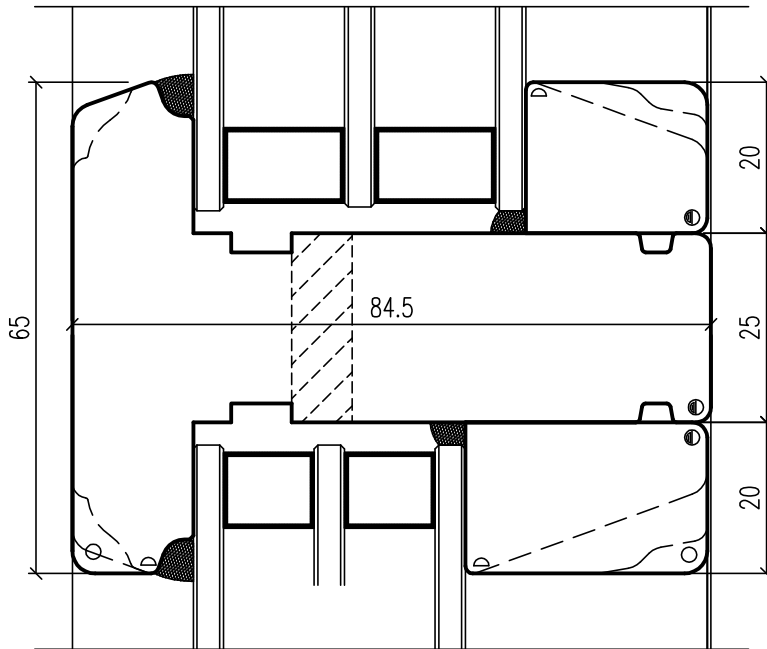
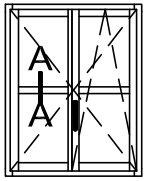

Ventana madera: 84.5mm  
(derivada de 68mm)  
Marco: esp.: 84.5mm  
Hoja: esp.: 84.5mm  
Vidrio: ?-?mm

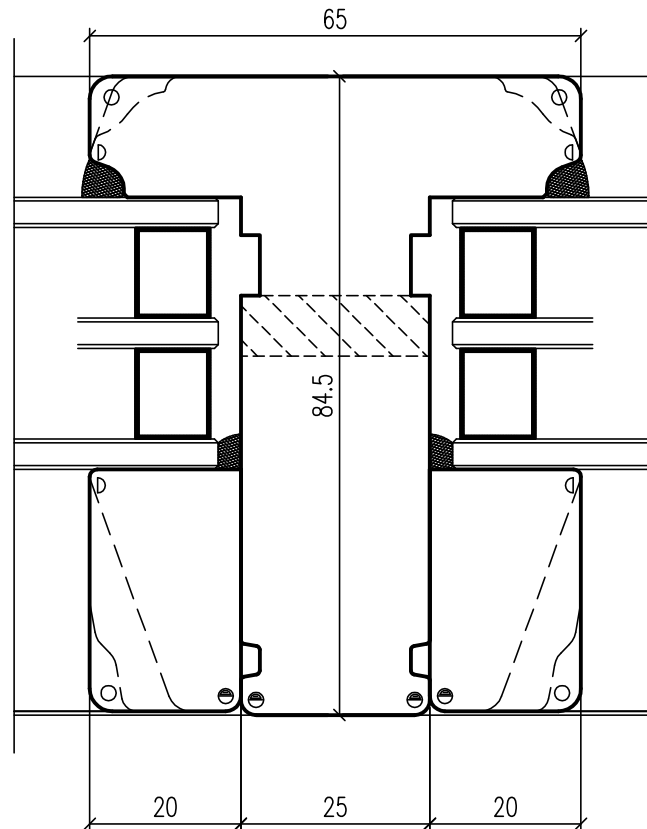
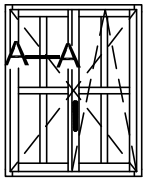

- ◐ R 1.0
- R 1.5
- R 2.0
- R 3.0

Coplanar 84,5mm

L 161509003 PZ09



# Coplanar

CON PORTILLO 84,5mm



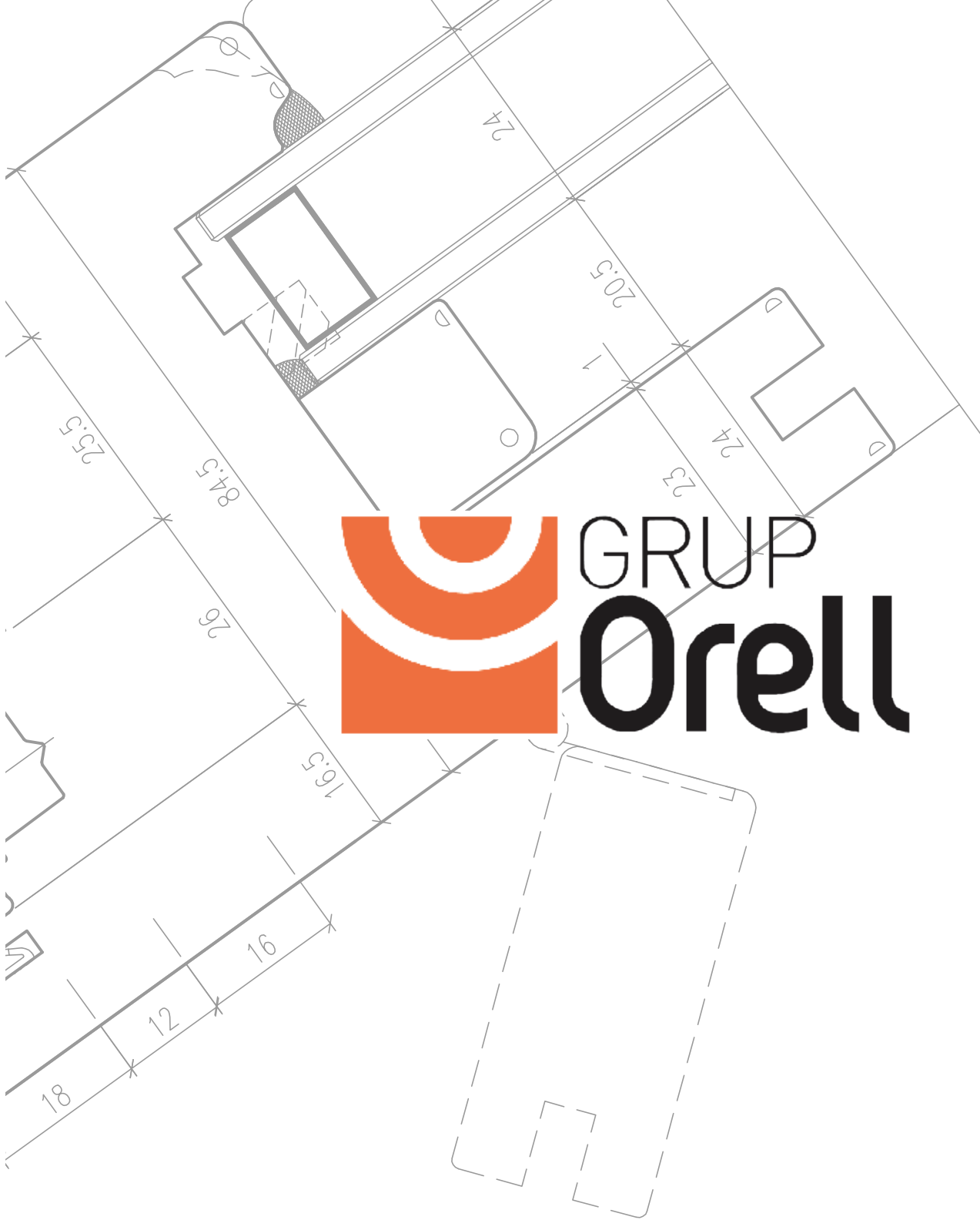

# Coplanar 84,5mm con portillo

Ventana madera:  
 > 84,5mm  
 (derivada de 68mm)

Marco: esp.:  
 > 84,5mm

Hoja: esp.:  
 > 84,5mm

Vidrio:  
 > ?÷?mm

L 161509003

KBZ: H84.5



Ventana madera: 84.5mm  
 (derivada de 68mm)  
 Marco: esp.: 84.5mm  
 Hoja: esp.: 84.5mm  
 Vidrio: ?÷?mm

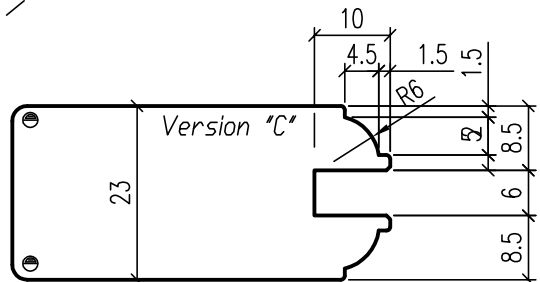
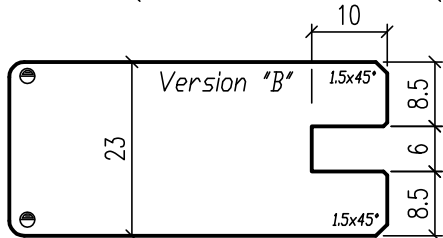
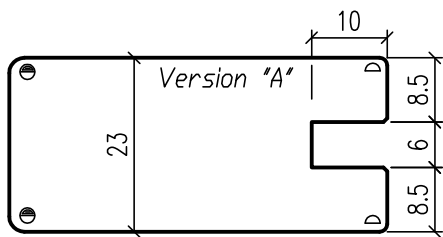
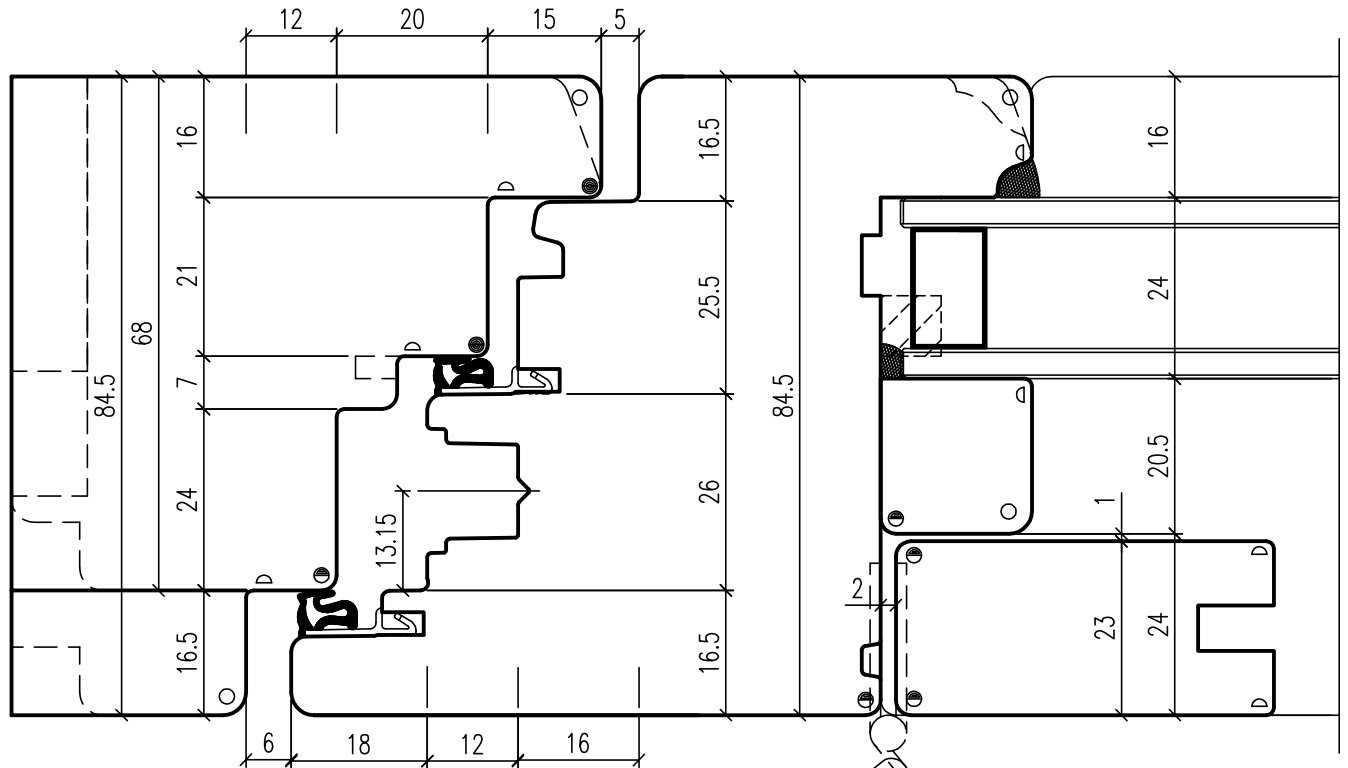
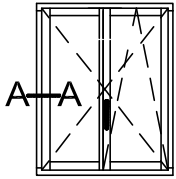

- ∅ R 1.0
- R 1.5
- R 2.0
- R 3.0

**Coplanar 84,5mm**

**L 161509003 PZ05**



# Coplanar

VENTANA DE MADERA 94,5mm





# Coplanar 94,5mm

Ventana madera:  
> 94,5mm  
(derivada de 78mm)

Marco: esp.:  
> 94,5mm

Hoja: esp.:  
> 94,5mm

Vidrio:  
> ?÷?mm

L 161509004

KBZ: H94.5



Ventana madera: 94.5mm  
(derivada de 78mm)  
Marco: esp.: 94.5mm  
Hoja: esp.: 94.5mm  
Vidrio: ?-?mm

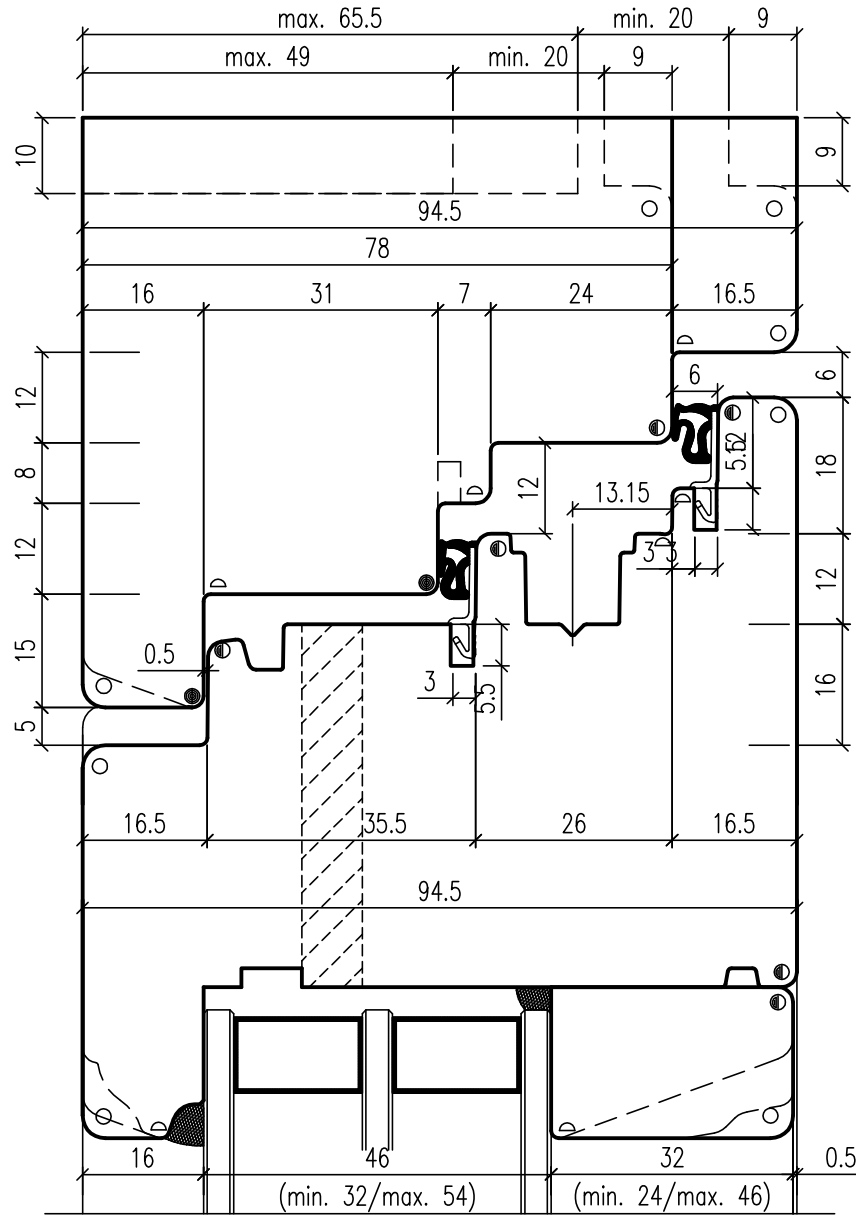
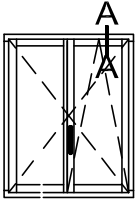

- ⊂ R 1.0
- R 1.5
- R 2.0
- R 3.0

**Coplanar 94,5mm**

**L 161509004 PZ01**



KBZ: H94.5



Ventana madera: 94.5mm  
(derivada de 78mm)  
Marco: esp.: 94.5mm  
Hoja: esp.: 94.5mm  
Vidrio: ?÷?mm

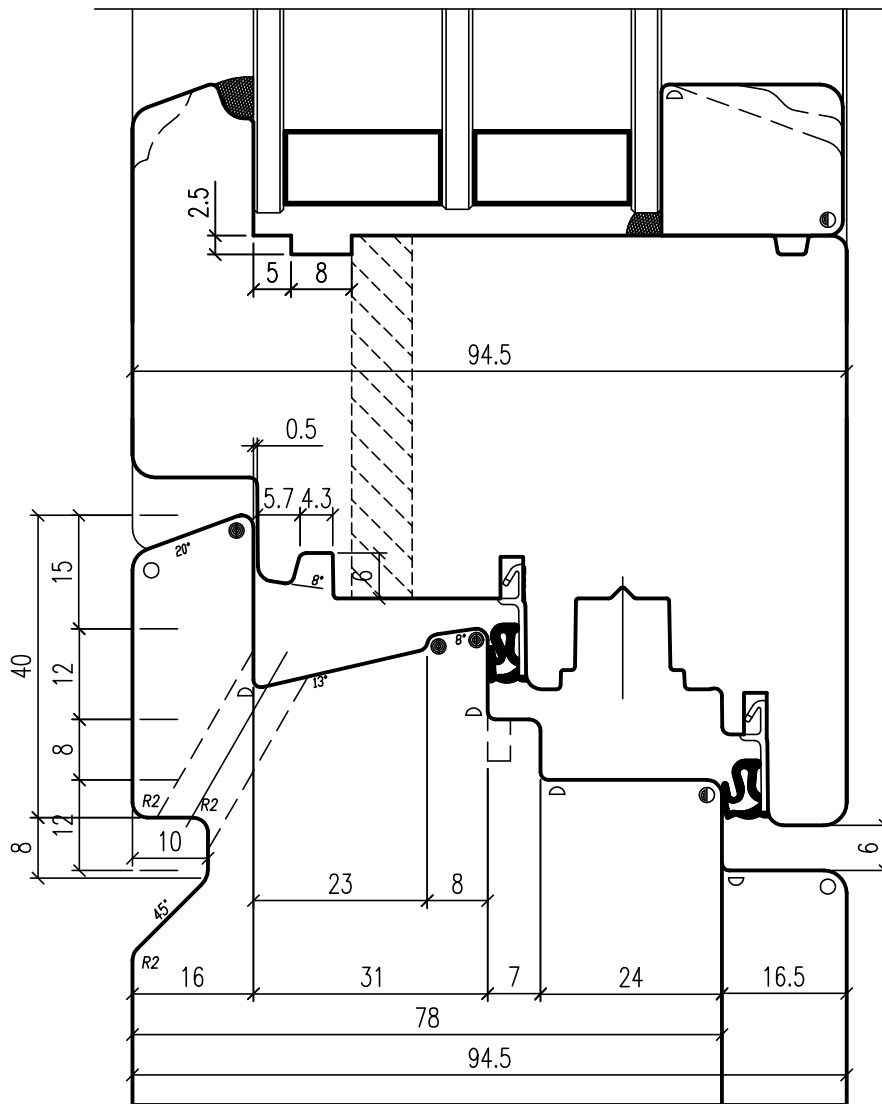
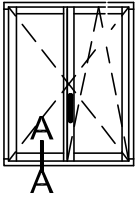

- ◐ R 1.0
- R 1.5
- R 2.0
- R 3.0

**Coplanar 94,5mm**

**L 161509004 PZ02**

KBZ: H94.5



Ventana madera: 94.5mm  
(derivada de 78mm)  
Marco: esp.: 94.5mm  
Hoja: esp.: 94.5mm  
Vidrio: ?÷?mm

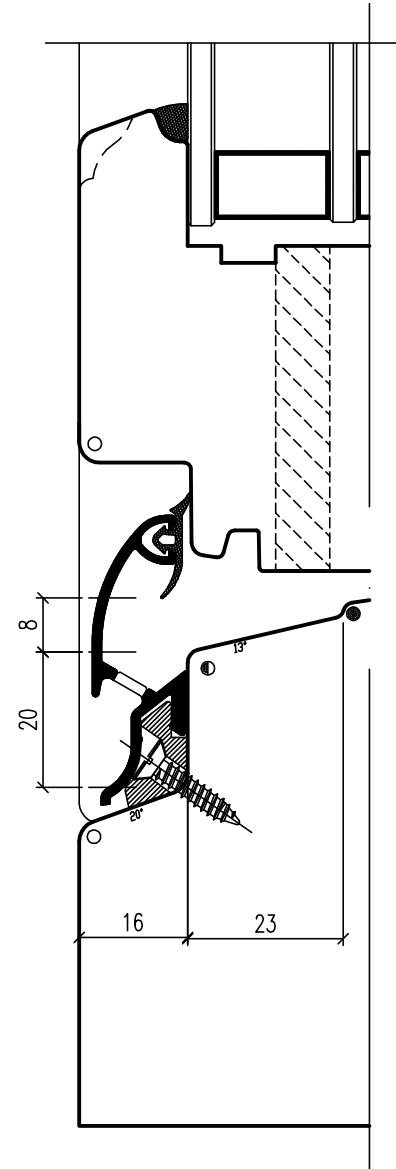
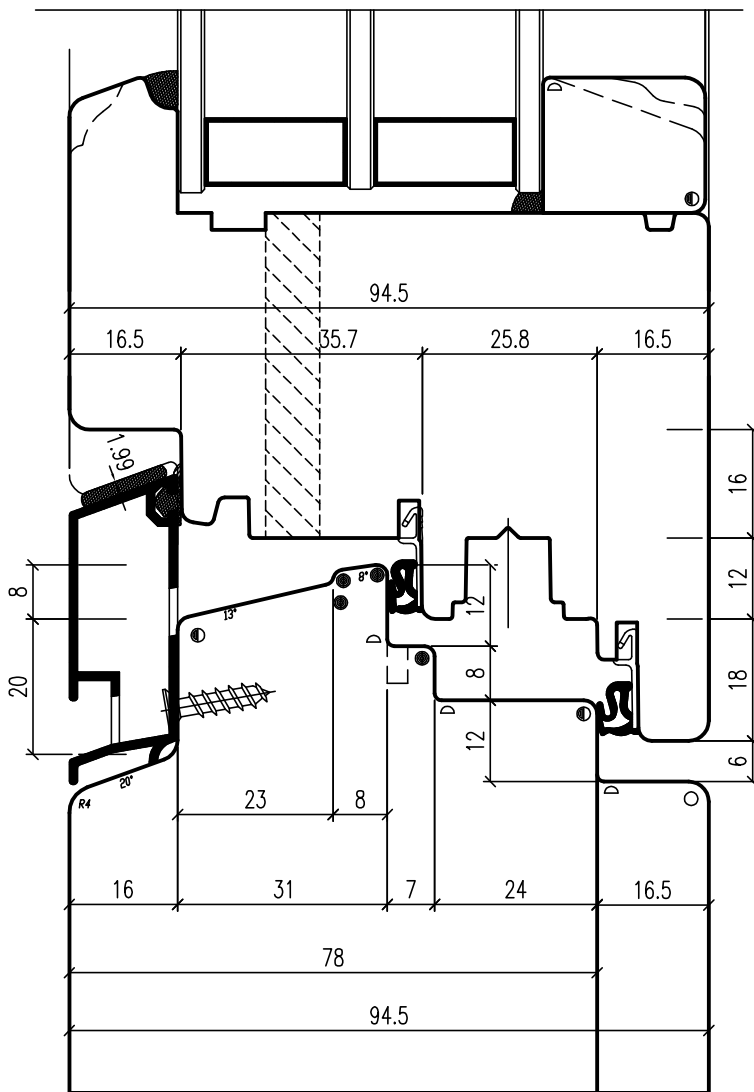
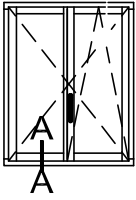

- ⊖ R 1.0
- R 1.5
- R 2.0
- R 3.0

Coplanar 94,5mm

L 161509004 PZ03

KBZ: H94.5



Ventana madera: 94.5mm  
(derivada de 78mm)  
Marco: esp.: 94.5mm  
Hoja: esp.: 94.5mm  
Vidrio: ?÷?mm

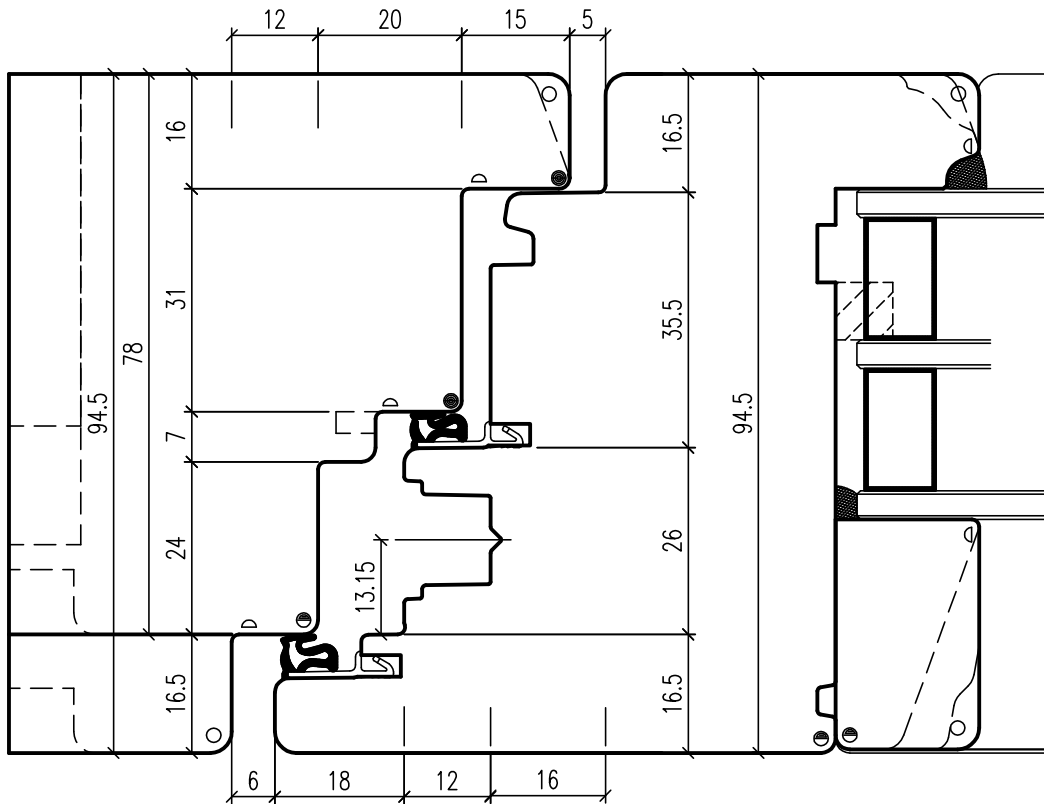
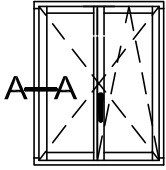

- ◐ R 1.0
- R 1.5
- R 2.0
- R 3.0

**Coplanar 94,5mm**

**L 161509004 PZ04**

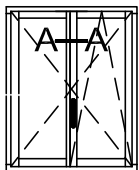

Variante 1  
Goma en el cierre central On-Off

Ventana madera: 94.5mm  
(derivada de 78mm)  
Marco: esp.: 94.5mm  
Hoja: esp.: 94.5mm  
Vidrio: ?÷?mm

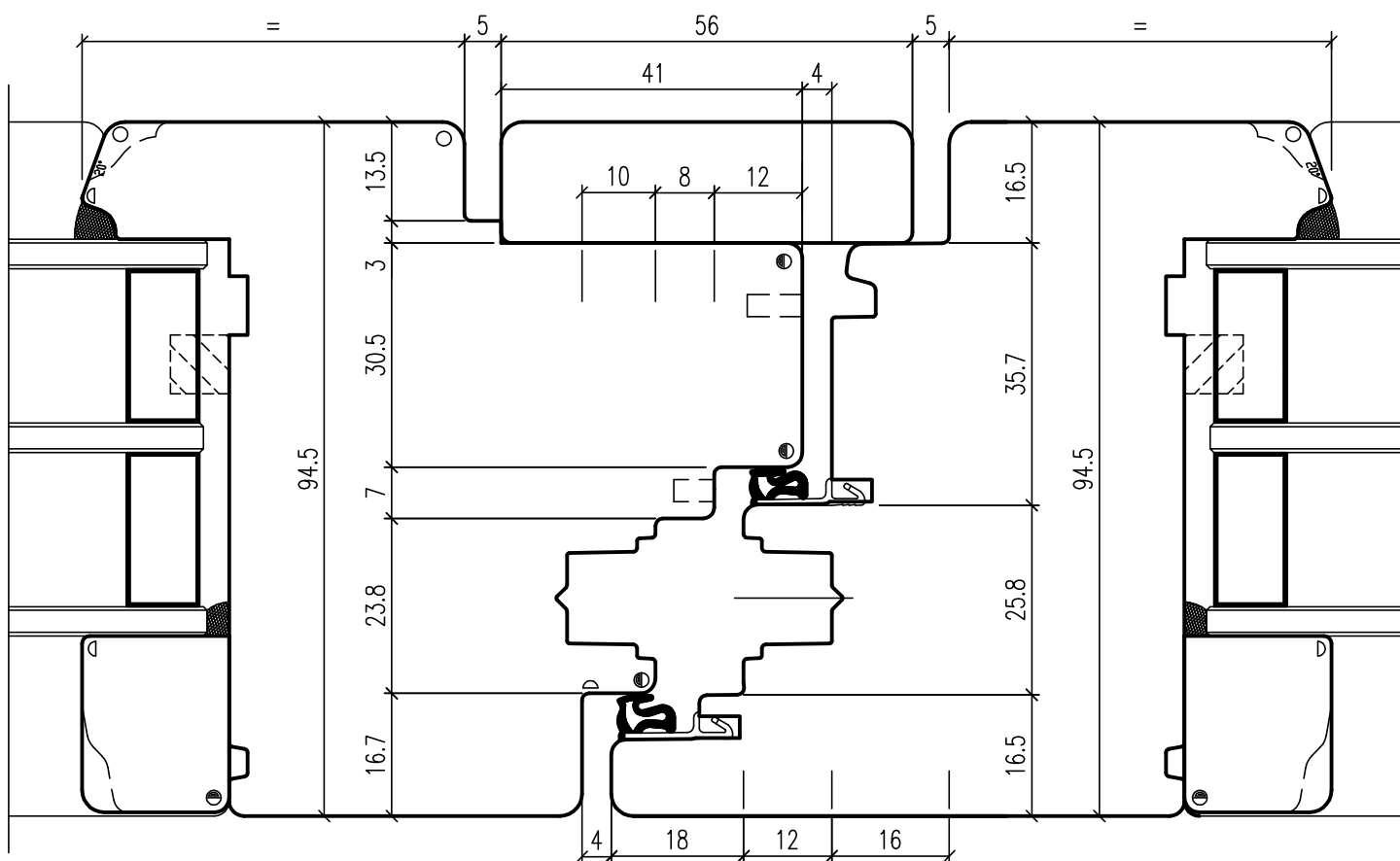
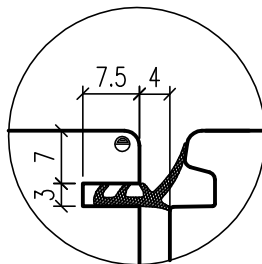

- ▷ R 1.0
- R 1.5
- R 2.0
- R 3.0

Coplanar 94,5mm

L 161509004 PZ06

KBZ: H94.5



Ventana madera: 94.5mm  
 (derivada de 78mm)  
 Marco: esp.: 94.5mm  
 Hoja: esp.: 94.5mm  
 Vidrio: ?÷?mm

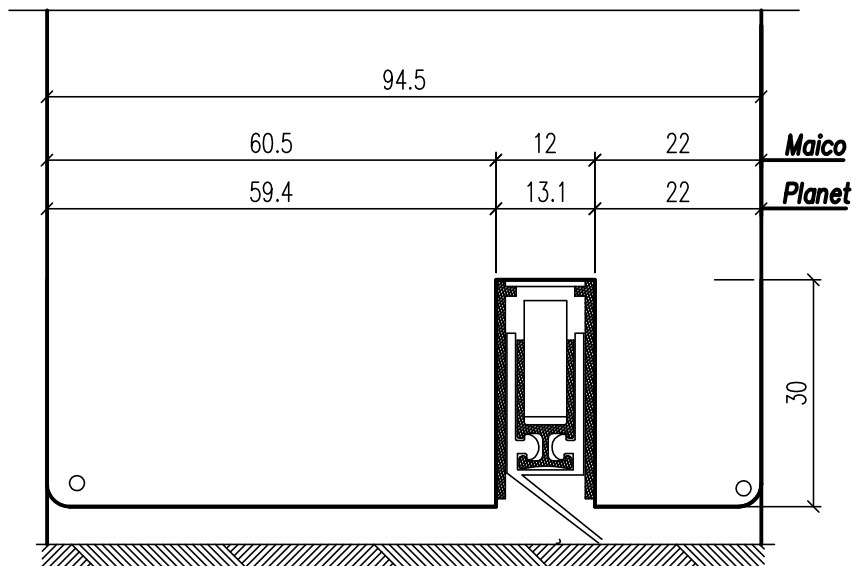
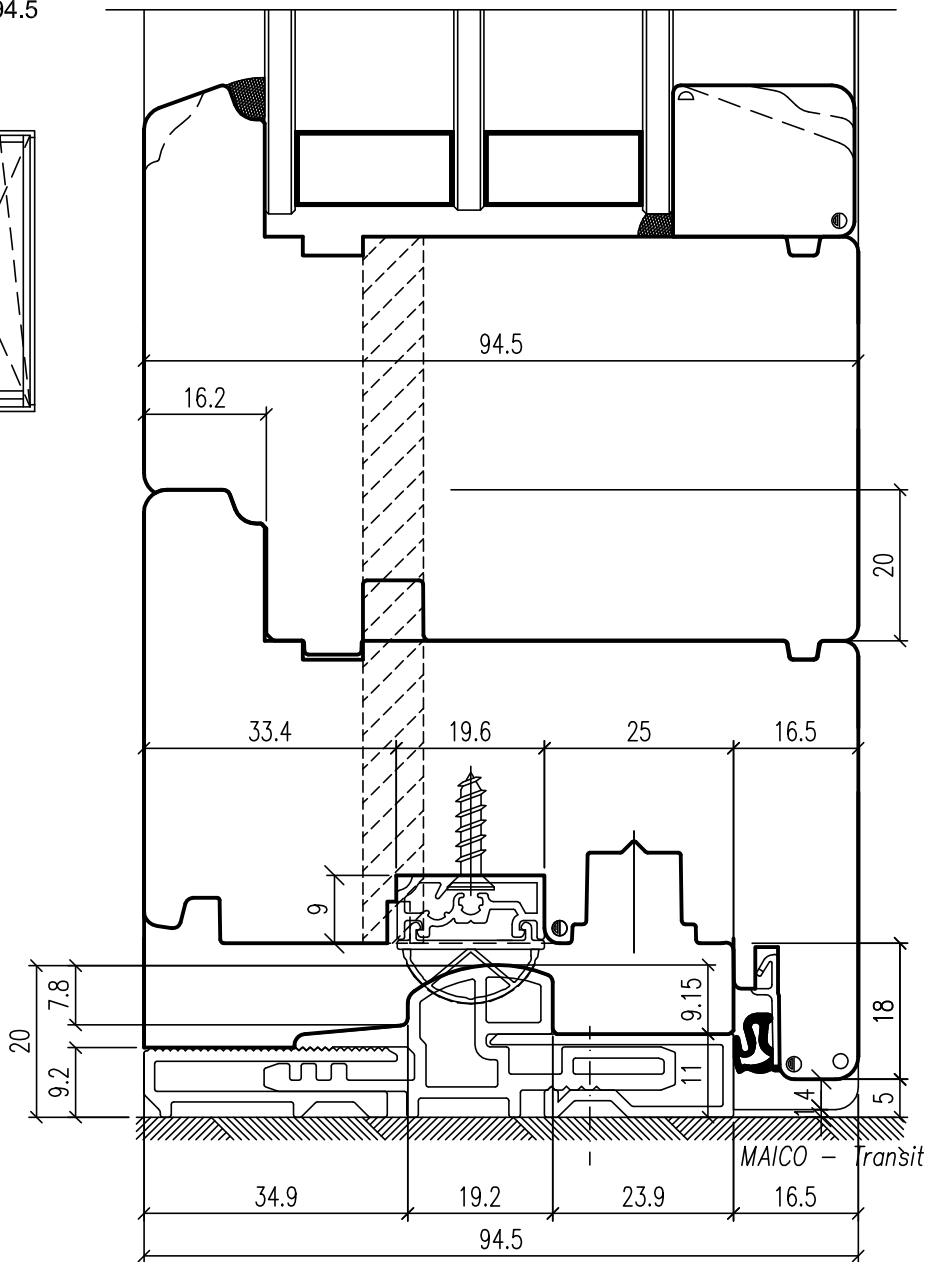
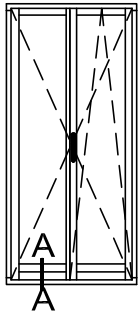

- ⊖ R 1.0
- R 1.5
- R 2.0
- R 3.0

**Coplanar 94,5mm**  
**L 161509004 PZ07**

KBZ: H94.5



Ventana madera: 94.5mm  
(derivada de 78mm)  
Marco: esp.: 94.5mm  
Hoja: esp.: 94.5mm  
Vidrio: ?÷?mm

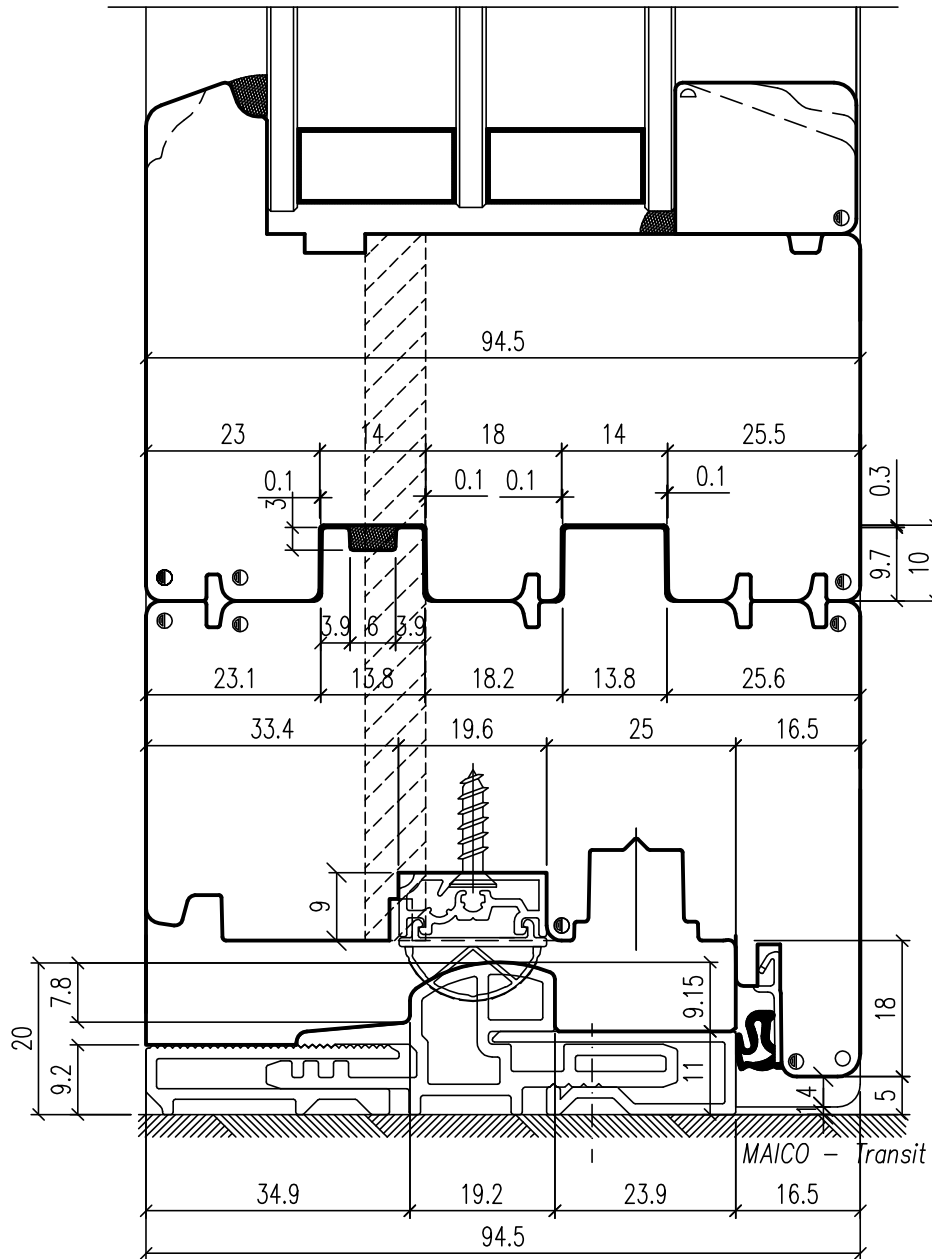
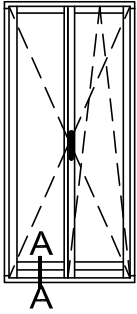

- ⊖ R 1.0
- R 1.5
- R 2.0
- R 3.0

**Coplanar 94,5mm**

**L 161509004 PZ08**

KBZ: H94.5



Ventana madera: 94.5mm  
(derivada de 78mm)  
Marco: esp.: 94.5mm  
Hoja: esp.: 94.5mm  
Vidrio: ?÷?mm

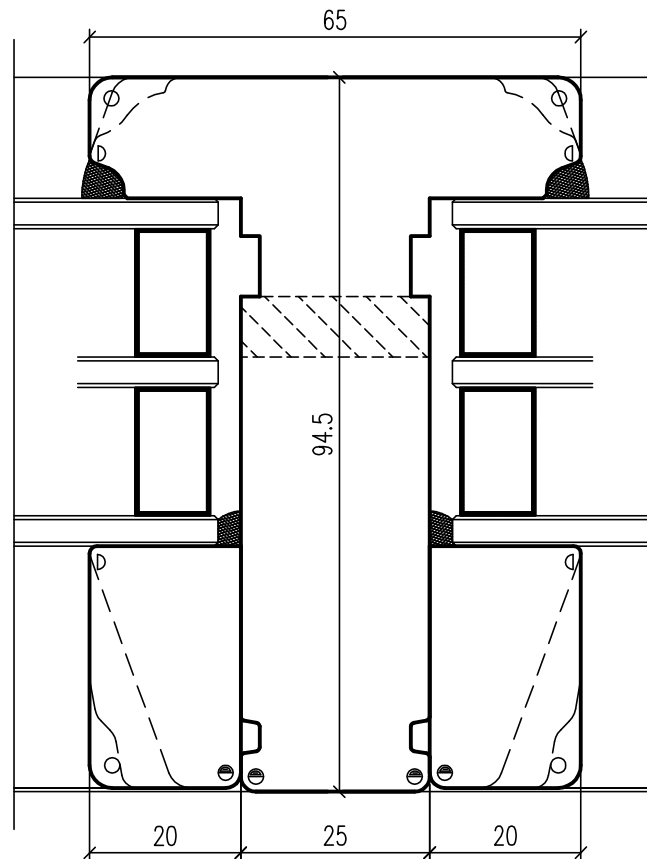
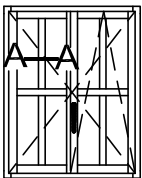
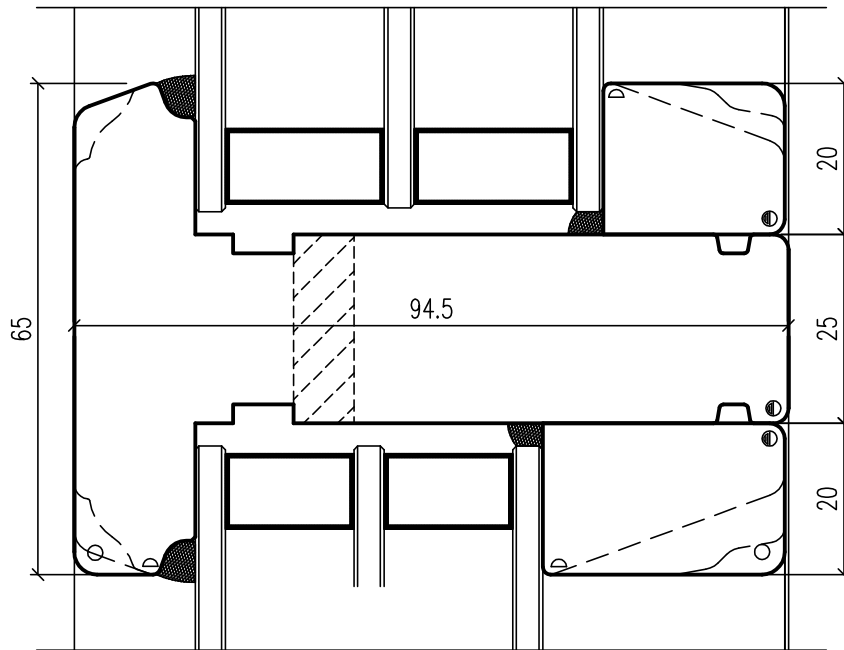
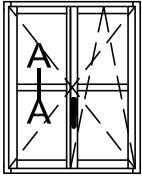

- ▷ R 1.0
- R 1.5
- R 2.0
- R 3.0

Coplanar 94,5mm

L 161509004 PZ09



# Coplanar

CON PORTILLO 94,5mm





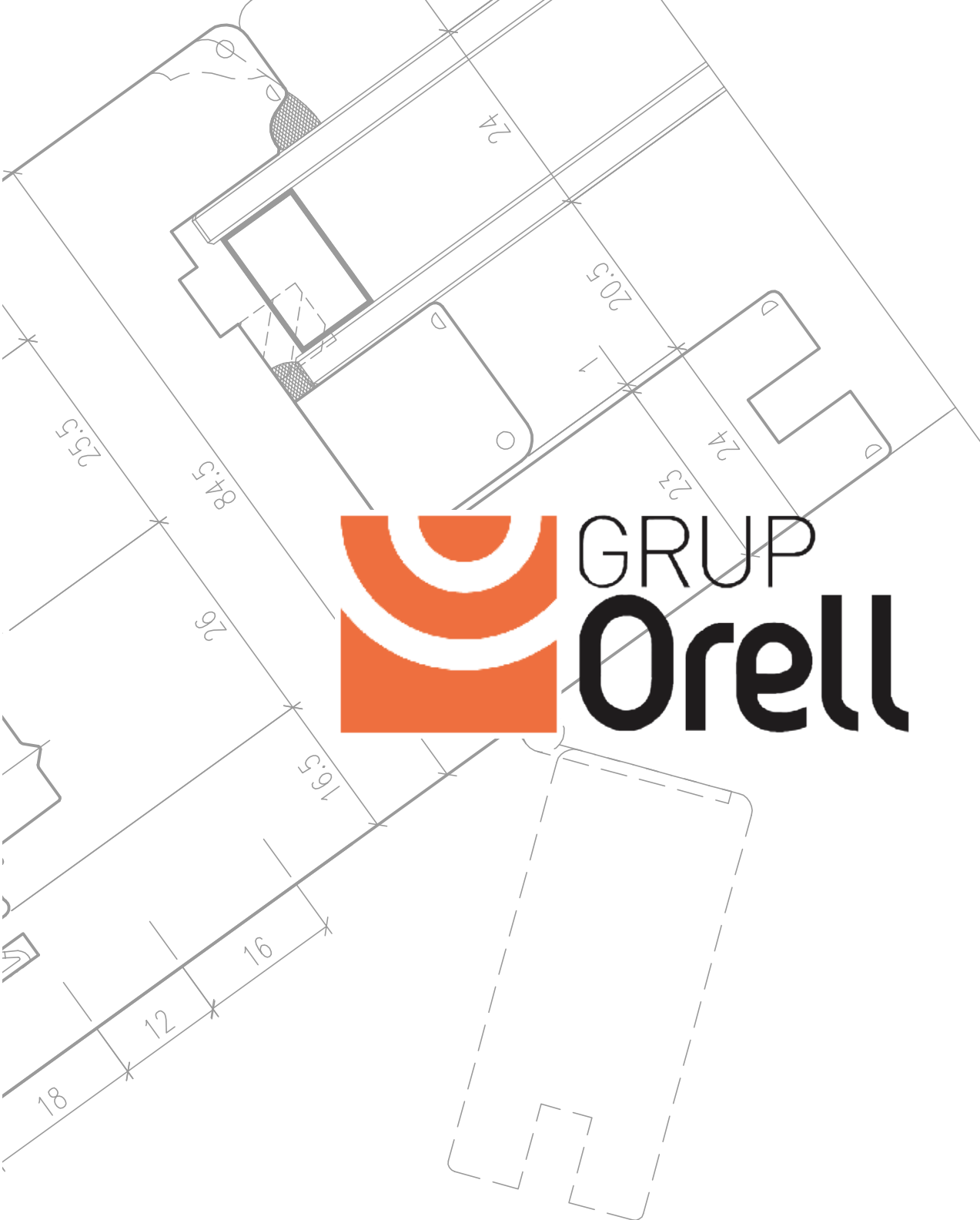

# Coplanar 94,5mm con portillo

Ventana madera:  
> 94,5mm  
(derivada de 78mm)

Marco: esp.:  
> 94,5mm

Hoja: esp.:  
> 94,5mm

Vidrio:  
> ?÷?mm

L 161509004

Ventana madera: 94.5mm  
 (derivada de 78mm)  
 Marco: esp.: 94.5mm  
 Hoja: esp.: 94.5mm  
 Vidrio: ?-?mm

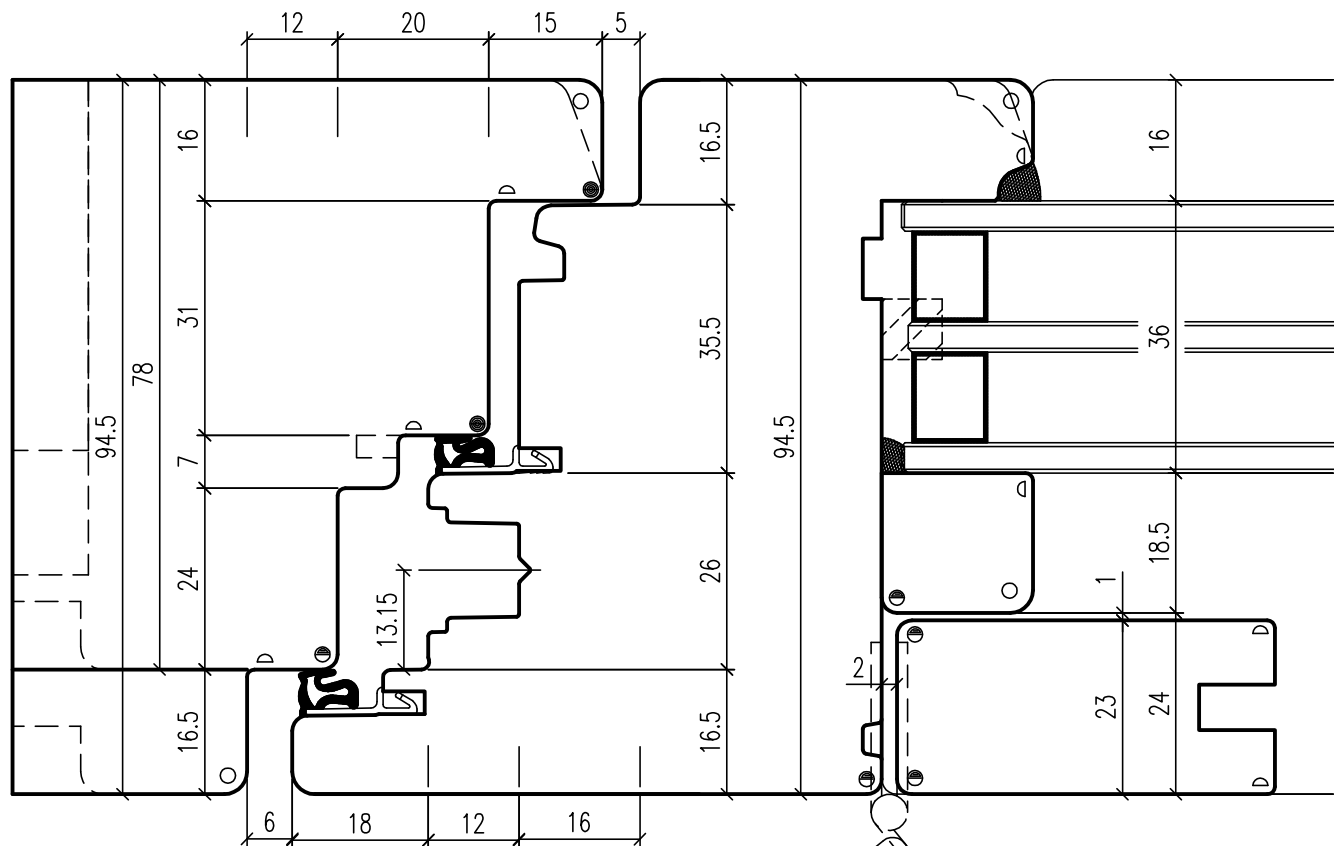
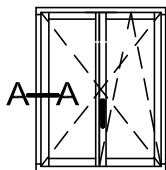

- R 1.0
- R 1.5
- R 2.0
- R 3.0

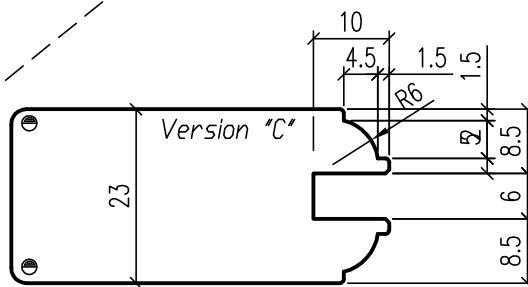
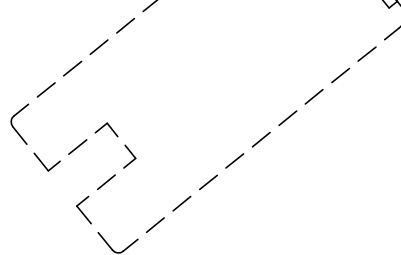
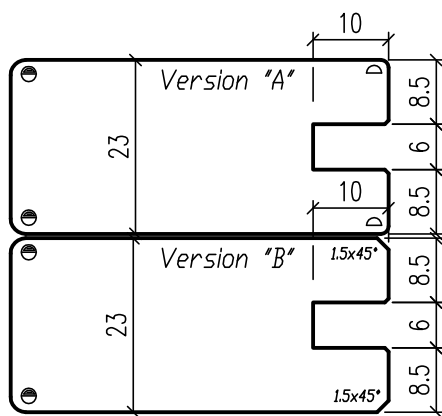

**Coplanar 94,5mm**

**L 161509004 PZ05**



# Coplanar

VENTANA DE MADERA 108,5mm





# Coplanar 108,5mm

Ventana madera:  
> 108,5mm  
(derivada de 92mm)

Marco: esp.:  
> 108,5mm

Hoja: esp.:  
> 108,5mm

Vidrio:  
> ?÷?mm

L 161509005

Ventana madera: 108.5mm  
 (derivada de 92mm)  
 Marco: esp.: 108.5mm  
 Hoja: esp.: 108.5mm  
 Vidrio: ?÷?mm

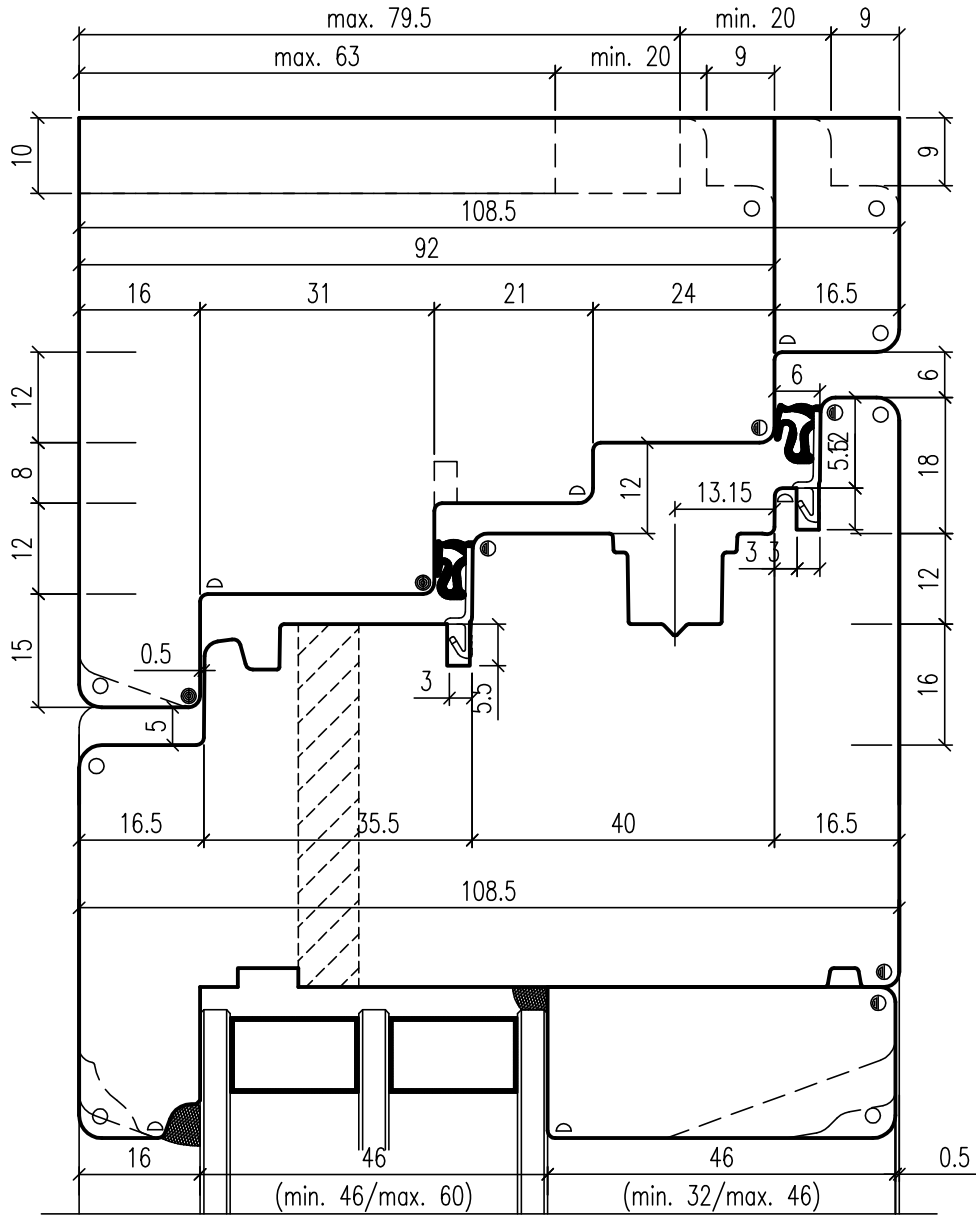
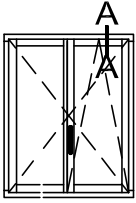

- ⌀ R 1.0
- R 1.5
- R 2.0
- R 3.0

**Coplanar 108,5mm**

**L 161509005 PZ01**

KBZ: H108.5



Ventana madera: 108.5mm  
(derivada de 92mm)  
Marco: esp.: 108.5mm  
Hoja: esp.: 108.5mm  
Vidrio: ?÷?mm

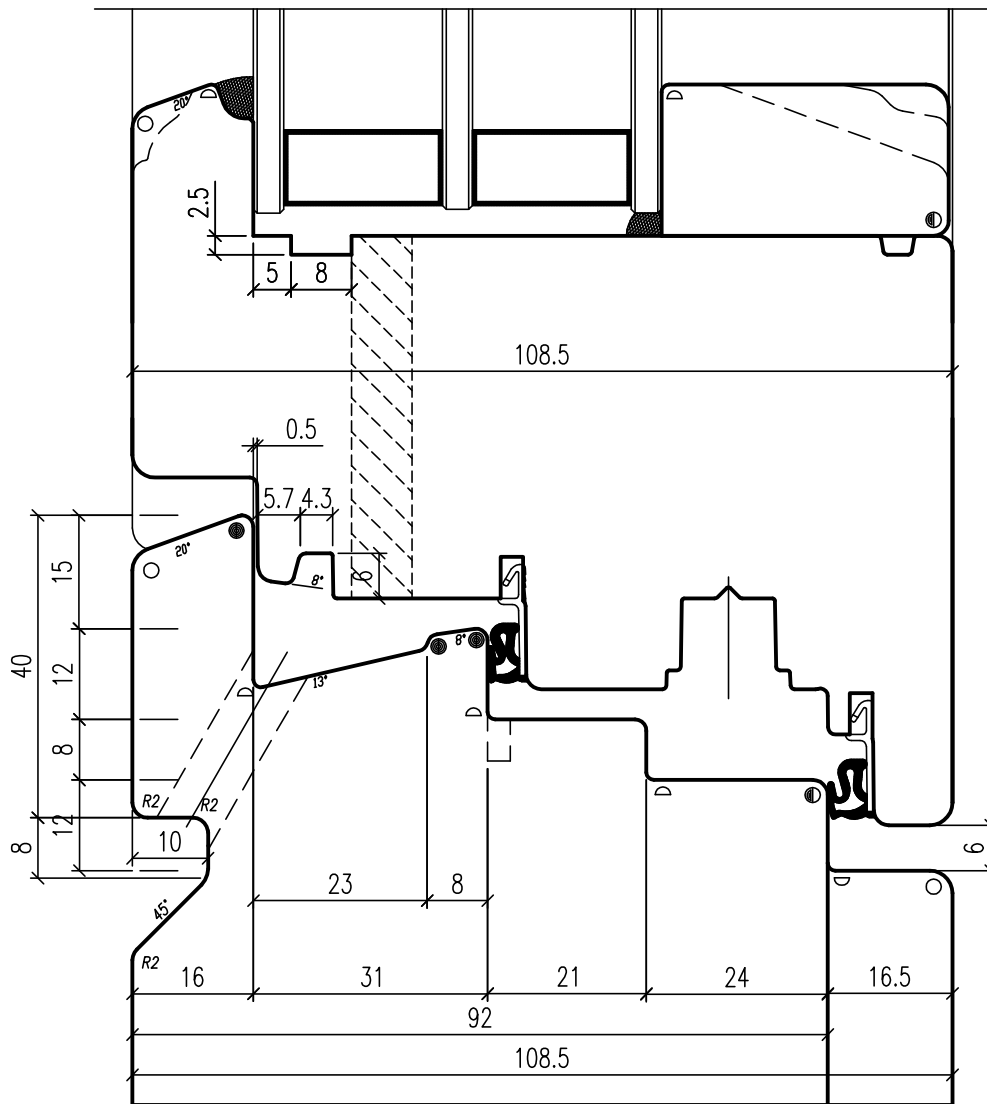
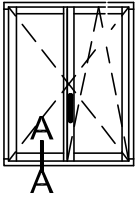

- ◐ R 1.0
- R 1.5
- R 2.0
- R 3.0

**Coplanar 108,5mm**

**L 161509005 PZ02**

KBZ: H108.5



Ventana madera: 108.5mm  
(derivada de 92mm)  
Marco: esp.: 108.5mm  
Hoja: esp.: 108.5mm  
Vidrio: ?÷?mm

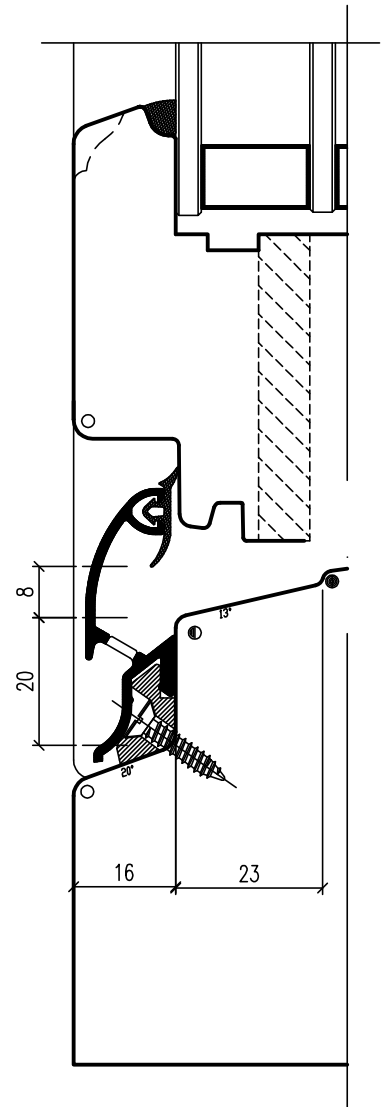
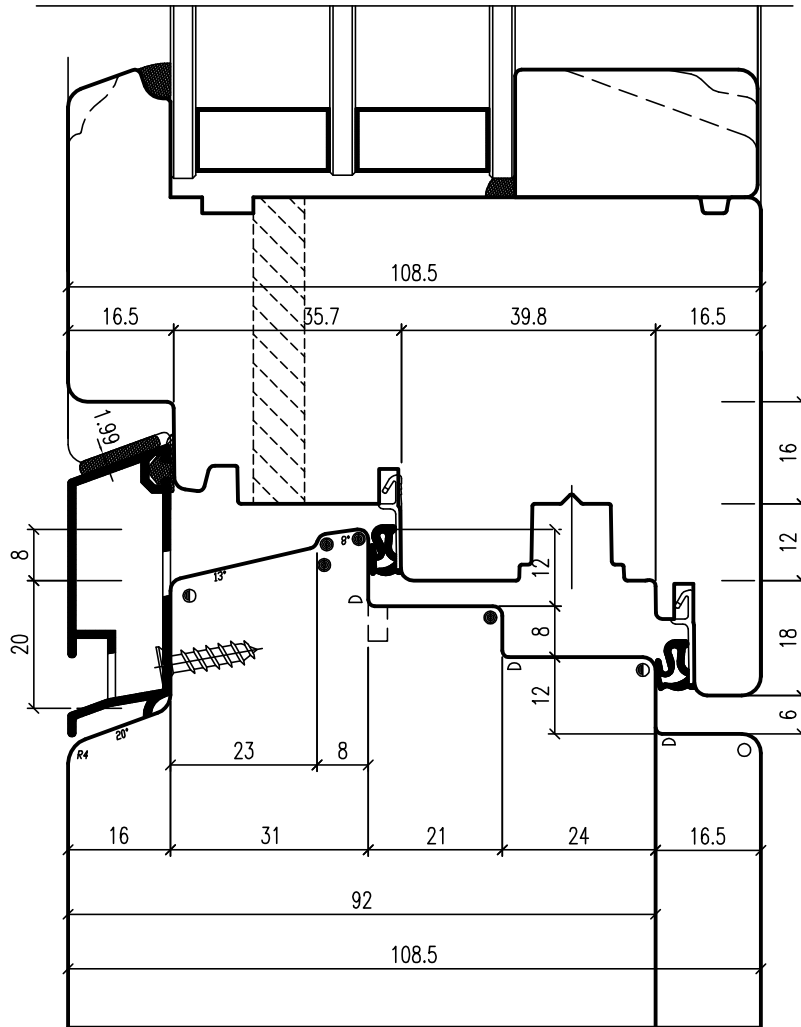
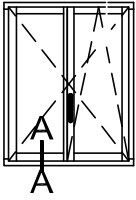

- ⊖ R 1.0
- R 1.5
- R 2.0
- R 3.0

**Coplanar 108,5mm**

**L 161509005 PZ03**

KBZ: H108.5



Ventana madera: 108.5mm  
(derivada de 92mm)  
Marco: esp.: 108.5mm  
Hoja: esp.: 108.5mm  
Vidrio: ?÷?mm

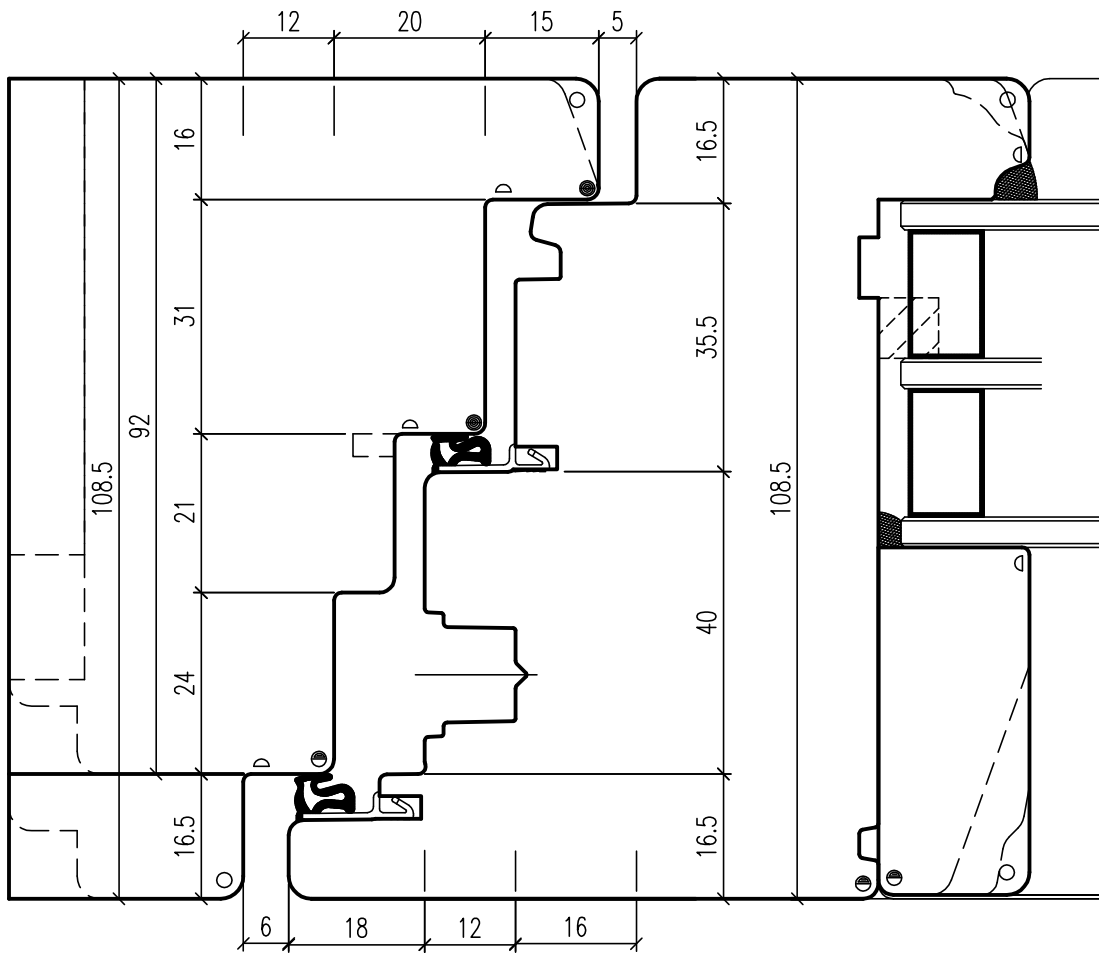
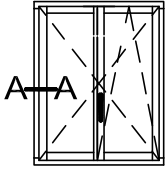

- △ R 1.0
- R 1.5
- R 2.0
- R 3.0

**Coplanar 108,5mm**

**L 161509005 PZ04**



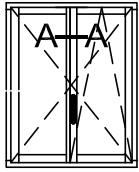

Variante 1  
Goma en el cierre central On-Off

Ventana madera: 108.5mm  
(derivada de 92mm)  
Marco: esp.: 108.5mm  
Hoja: esp.: 108.5mm  
Vidrio: ?÷?mm

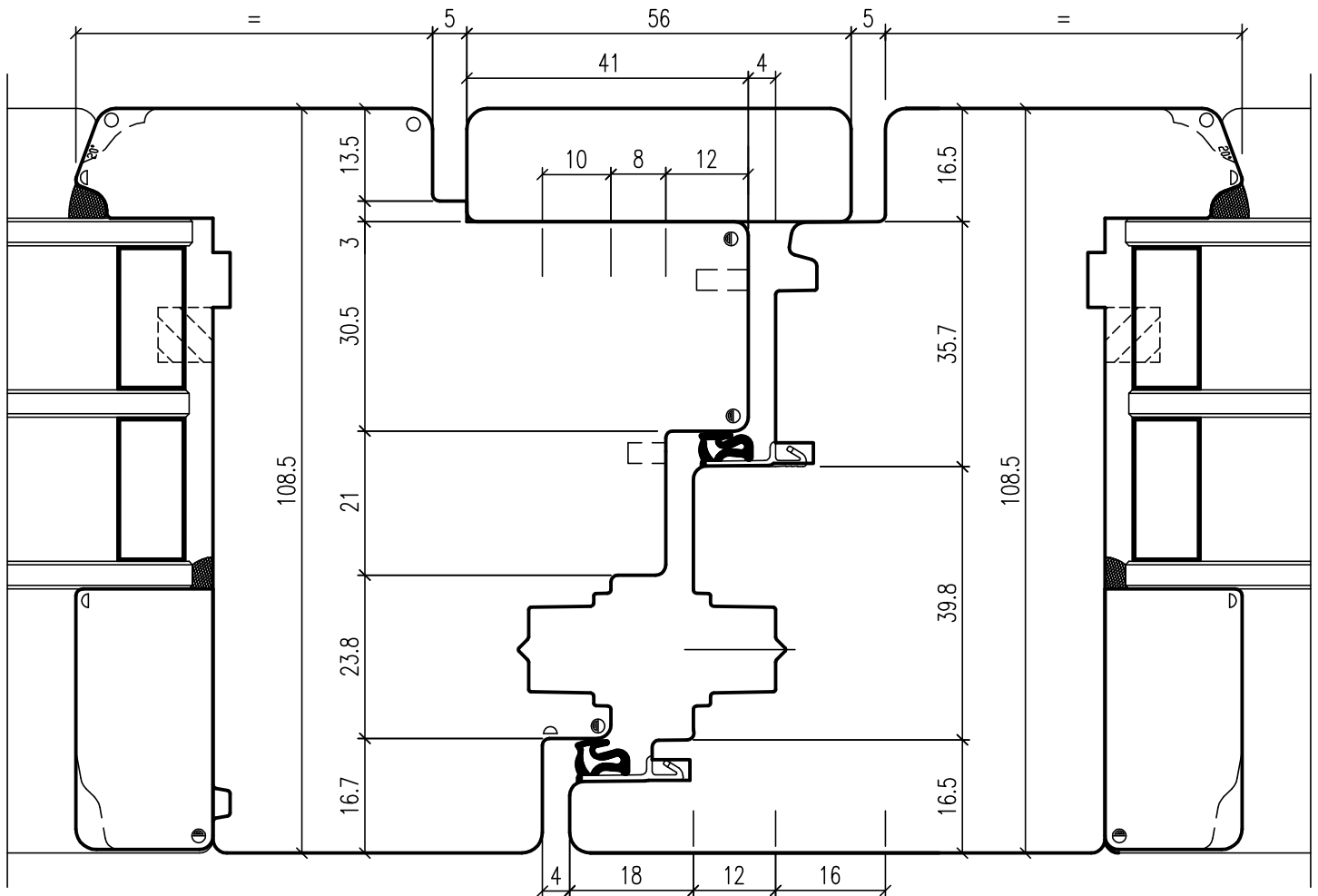
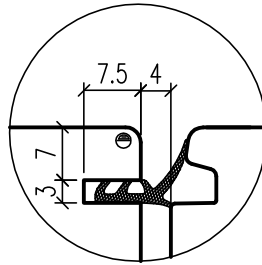

- ∅ R 1.0
- R 1.5
- R 2.0
- R 3.0

**Coplanar 108,5mm**

**L 161509005 PZ06**

KBZ: H108.5



Ventana madera: 108.5mm  
 (derivada de 92mm)  
 Marco: esp.: 108.5mm  
 Hoja: esp.: 108.5mm  
 Vidrio: ?÷?mm

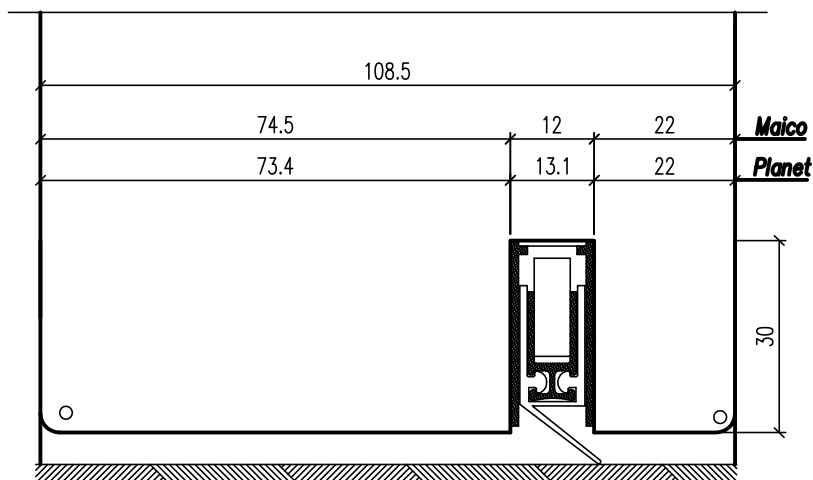
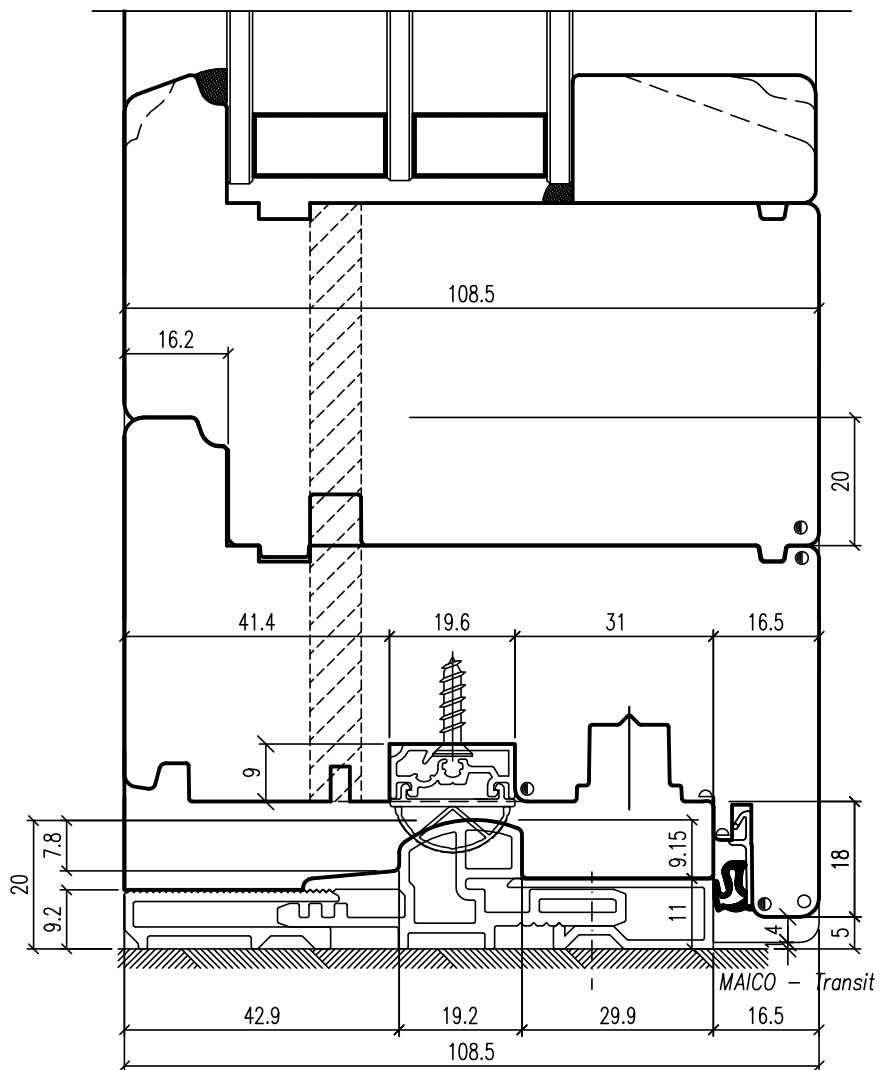
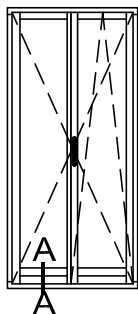

- ⊖ R 1.0
- R 1.5
- R 2.0
- R 3.0

Coplanar 108,5mm

L 161509005 PZ07

Ventana madera: 108.5mm  
 (derivada de 92mm)  
 Marco: esp.: 108.5mm  
 Hoja: esp.: 108.5mm  
 Vidrio: ?÷?mm

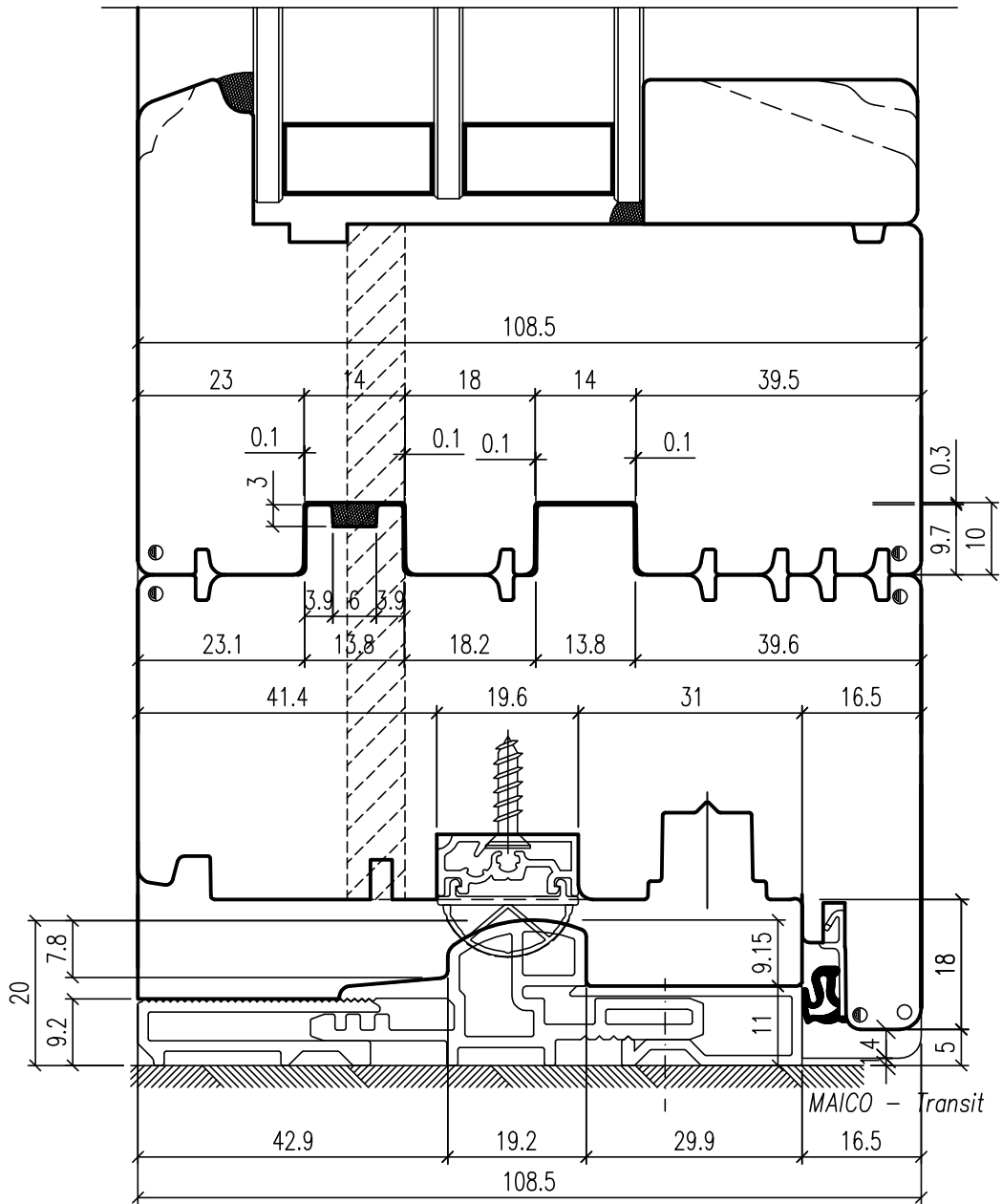
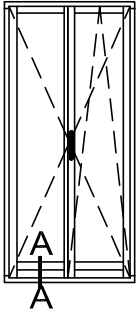

- R 1.0
- R 1.5
- R 2.0
- R 3.0

**Coplanar 108,5mm**

**L 161509005 PZ08**

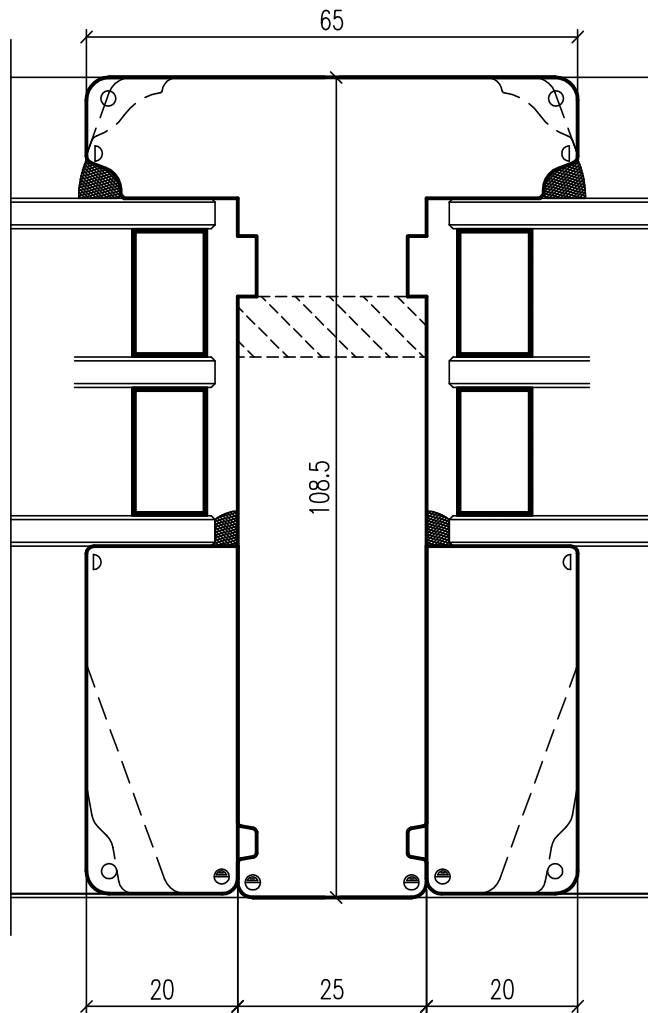
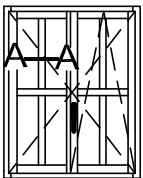
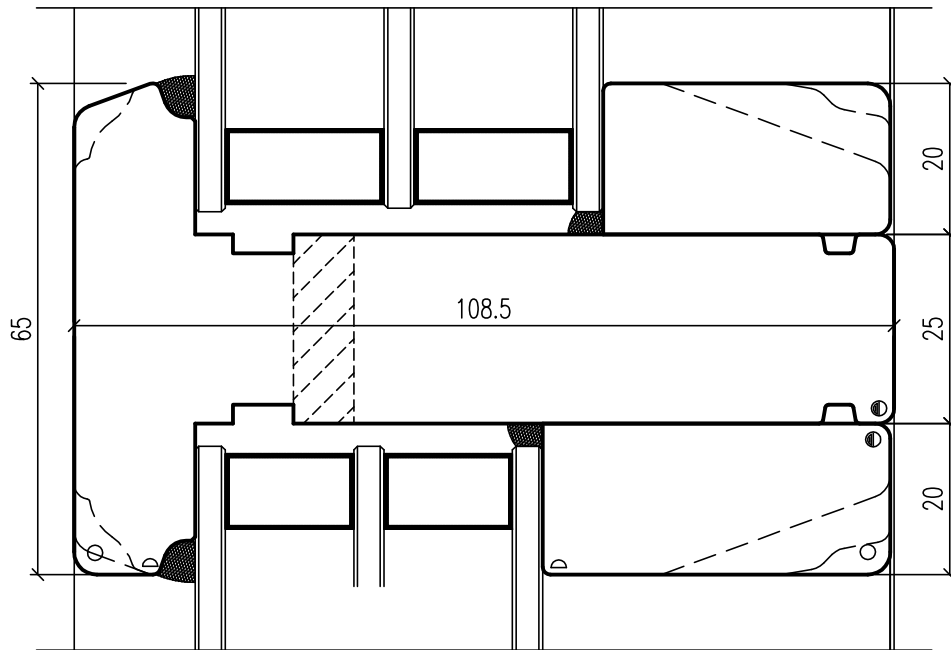
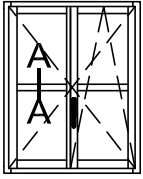

Ventana madera: 108.5mm  
 (derivada de 92mm)  
 Marco: esp.: 108.5mm  
 Hoja: esp.: 108.5mm  
 Vidrio: ?÷?mm

- ▷ R 1.0
- R 1.5
- R 2.0
- R 3.0

**Coplanar 108,5mm**

**L 161509005 PZ09**



# Coplanar

CON PORTILLO 108,5mm



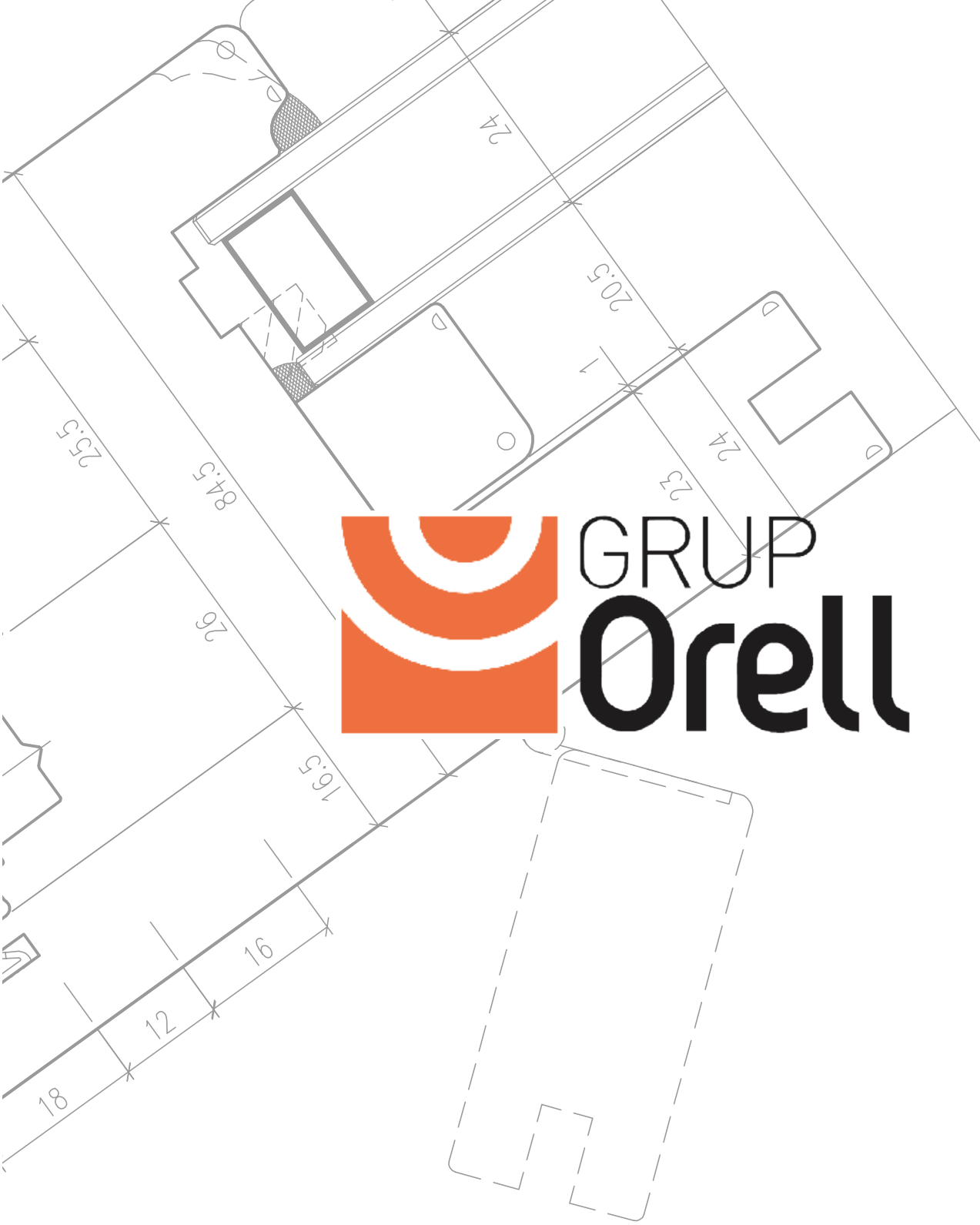

# Coplanar 108,5mm con portillo

Ventana madera:  
> 108,5mm  
(derivada de 92mm)

Marco: esp.:  
> 108,5mm

Hoja: esp.:  
> 108,5mm

Vidrio:  
> ?÷?mm

L 161509005

Ventana madera: 108.5mm  
 (derivada de 92mm)  
 Marco: esp.: 108.5mm  
 Hoja: esp.: 108.5mm  
 Vidrio: ?÷?mm

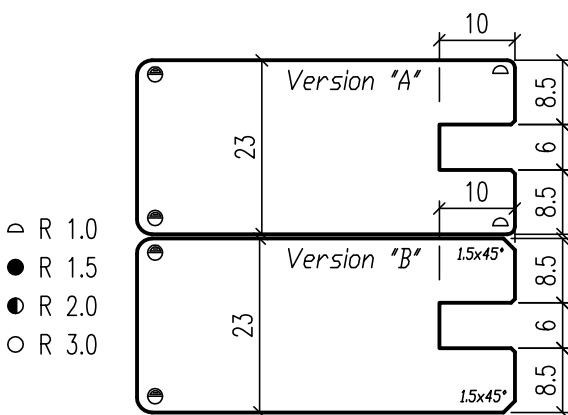
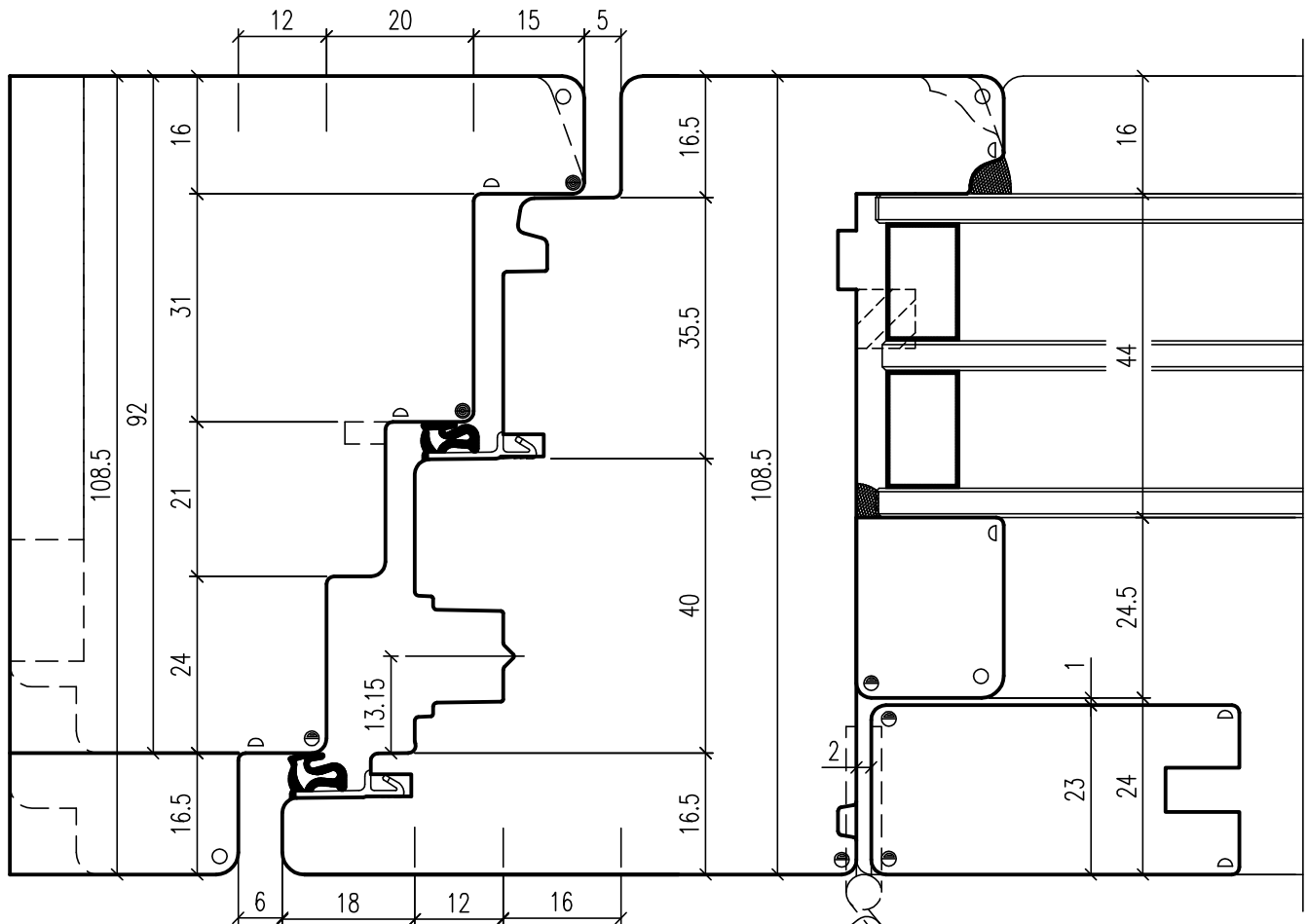
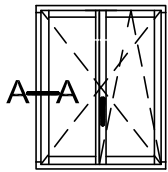

- D R 1.0
- R 1.5
- R 2.0
- O R 3.0

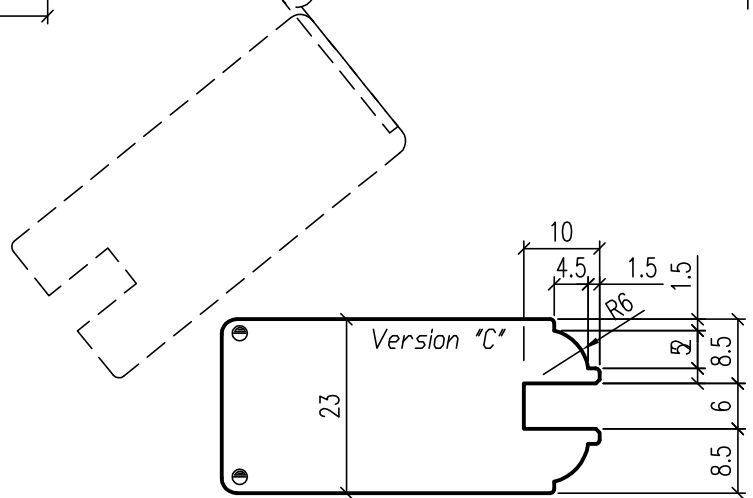

**Coplanar 108,5mm**

**L 161509005 PZ05**